

**DANCOVER<sup>®</sup>**



Manual  
for  
Storage Tent  
3m Series PVC

# DANCOVER<sup>®</sup>

.com

## Safety Advice

### Attention

In some countries approval is needed to set up a tent larger than 75 m<sup>2</sup>. It is your responsibility to comply with local rules and regulations and to ensure that the tent is assembled correctly.

In case of bad weather conditions, it is your responsibility to ensure the tent is safely secured and that the tent does not cause damage to others.

Do not use open fire, welding equipment or other sources which can ignite, inside or close to the tent.

The tent must be safely secured. We recommend you secure your tent with straps and pegs as soon as it is assembled.

Make sure to check if the tent is covered by your home contents insurance.

Tents must be evacuated under extreme weather conditions.

In the event of snow, always remove snow from the roof of the tent regularly to prevent snow from building on the roof, as heavy snow can cause the tent to collapse.

In the event of rain, there is a risk of rain puddles building up on top of the roof of the tent. Heavy rain puddles can cause the roof to collapse. It is your responsibility to ensure rain puddles do not build up. As a precaution, make sure the roof of the tent is stretched out properly and adequately over the side frames of the tent and remove rain water regularly.

Do not unpack or repack your tent in freezing temperatures. In case of temperatures below zero, always unpack and repack your tent indoors to avoid the risk of cracking parts.

The tent must be totally dry before you repack and store it to avoid mildew.

**Note:** Dancover warranty applies only to the normal use of the Product, normal wear and tear excepted, in accordance with written use instructions or manual. The warranty does not apply to damage caused by accident, abuse, misuse, or modification of the Product.

## Warranty Information

Please visit [dancovershop.com](http://dancovershop.com) for information on warranty.

*Please always check our website for the latest safety advice and manual.*











## Warning

---

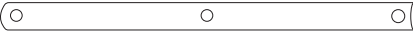
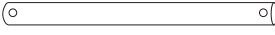





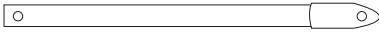
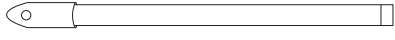

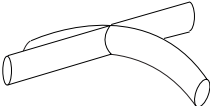
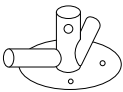
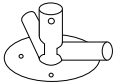
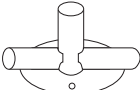

1. In order to avoid being rusted by air, oil is covered on the surface of the pipes, before set up the tent, please remove the oil carefully first to keep the cover clean.
2. Take note that the tent needs to be handled carefully to avoid damage.
3. Do not force the frame as they may be damaged in the process.
4. Tents are meant as temporary shelter and must be evacuated under extreme weather conditions.

Please select a suitable site for the tent to avoid the damage to underground sprinkler systems, water, gas or electrical lines.

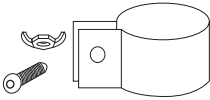
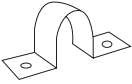



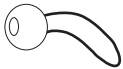

# 3m Storage tent manual

Part No.			3x6m	3x8m
1	Middle leg 1880mm Ø50		4	6
2	Frame pole 1880mm Ø38		11	16
3-1	Frame pole 1880mm Ø38		2	2
3-2	Frame pole 1880mm Ø38		2	2
4	Frame pole 1455mm Ø50		8	10
5	Groundbar pipe		4	4
6	Diagonal support 1158mm Ø25		4	4
7	Roof support 1652mm Ø25		4	5
8	Corner leg 1880mm Ø50		4	4
9	Male doorbar 1965mm Ø38		2	2
11	Pillar 1140mm Ø50		4	4
12	Pillar 1140mm Ø50		4	4
13	Ceiling rail 1070mm Ø25		2	2

# 3m Storage tent manual

Part No.			3x6m	3x8m
14	Ceiling rail 1070mm Ø25		2	2
15-1	3-way connector 54-42mm (A)		6	6
15-2	4-way connector 54-42mm (B)		6	9
16	3-way connector for corner		2	2
17	3-way connector for corner		2	2
18	3-way connector for sidewall		8	10
23	Strengthen bar		6	8
24	Bracket		12	14
25	Groundbracket		6	8
26	Peg 400mm		12	16
27	Spiral peg		4	4
28	Long peg		12	14
29	Small peg		32	36
30	Bungeeball long		44	44
31	Rope		4	4

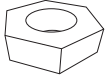
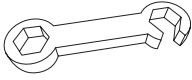
# 3m Storage tent manual

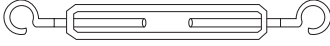
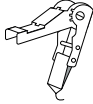
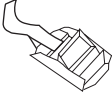
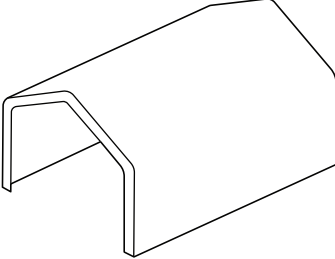
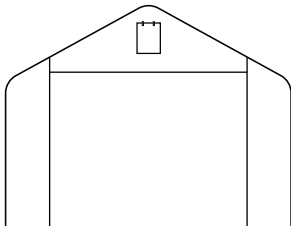
Part No.			3x6m	3x8m
32	Screw M6x30		14	16
35	M6 wingnut		14	16
37	Screw M8x50mm		50	60
38	Screw M8x60mm		48	56
39	M8 nut		98	116
40	Spanner		1	1
41	Steel tension bar		12	16
42	Turnbuckle		6	8
43	Tie down		4	4
44	Steel clip		20	24
45	Roof		1	1
46	Endwall		2	2

3m storage pro	Part 32		Part 35		Part 37		Part 38		Part 39	
	M6x30 Screw		M6 Wing nut		M8x50 Screw (Ø42)		M8x60 Screw (Ø54)		M8 Nut	
	3x6	3x8	3x6	3x8	3x6	3x8	3x6	3x8	3x6	3x8
Used for Part 4 and Part 7	8	10								
Used for Part 13 and Part 14	2	2								
Used for Part 12 and Part 13	2	2								
Used for Part 12 and Part 14	2	2								
Used for Part 3-1 and Part 6					2	2				
Used for Part 3-2 and Part 6					2	2				
Used for Part 6 and Part 8							4	4		
Used for Part 11 and Part 12							4	4		
Used for 3-way connector A					6	6	12	12		
Used for 4-way connector B					12	18	12	18		
Used for 3-way connector 16					4	4	2	2		
Used for 3-way connector 17					4	4	2	2		
Used for 3-way connector 18					16	20	8	10		
Used for M6x30			14	16						
Used for M8x50									46	56
Used for M8x65									44	52
	14	16	14	16	46	56	44	52	90	108

I

Select a flat ground for the tent, unpack the carton and check all the parts including tubes, tent and accessories... etc. are present and the same as the list.

Assemble the framework of rooftop by joining the portion (15-1.15-2) together with poles (2.3-1.3-2.4) NO.3 is on four corners for diagonal pipe

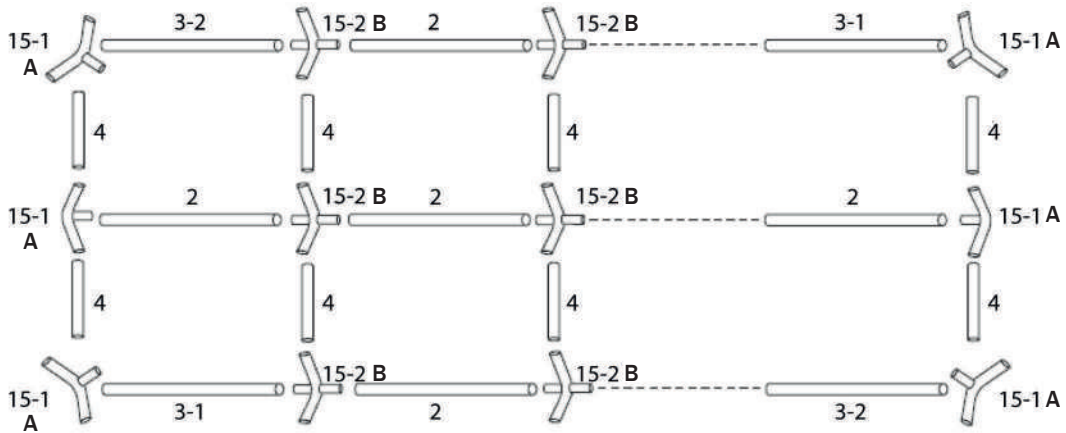

II

To ensure the screw fixed to every pole tightly. And then use the turnbuckle and steel tension bar to tighten the top structure.

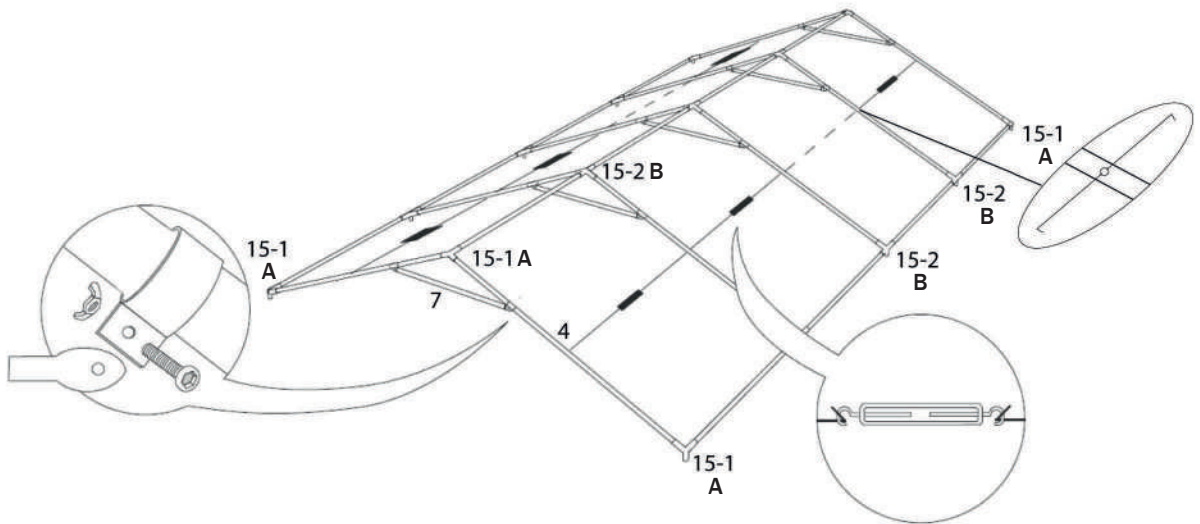

III

Attach one end of supported pole (1.8) to the joints

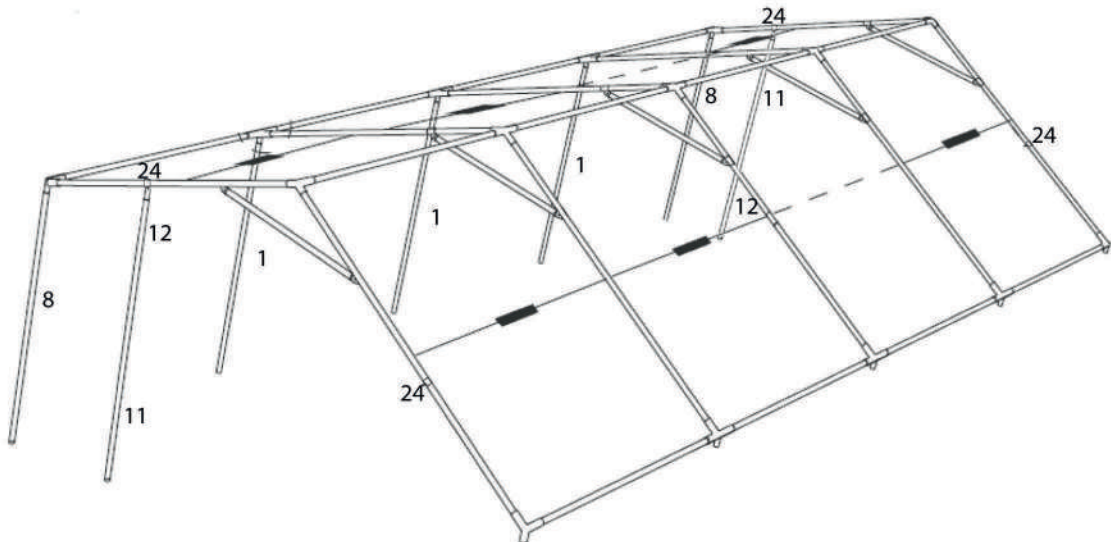



#### IV

Attach the another supported poles (1.8) to the joints, built-up the framework.

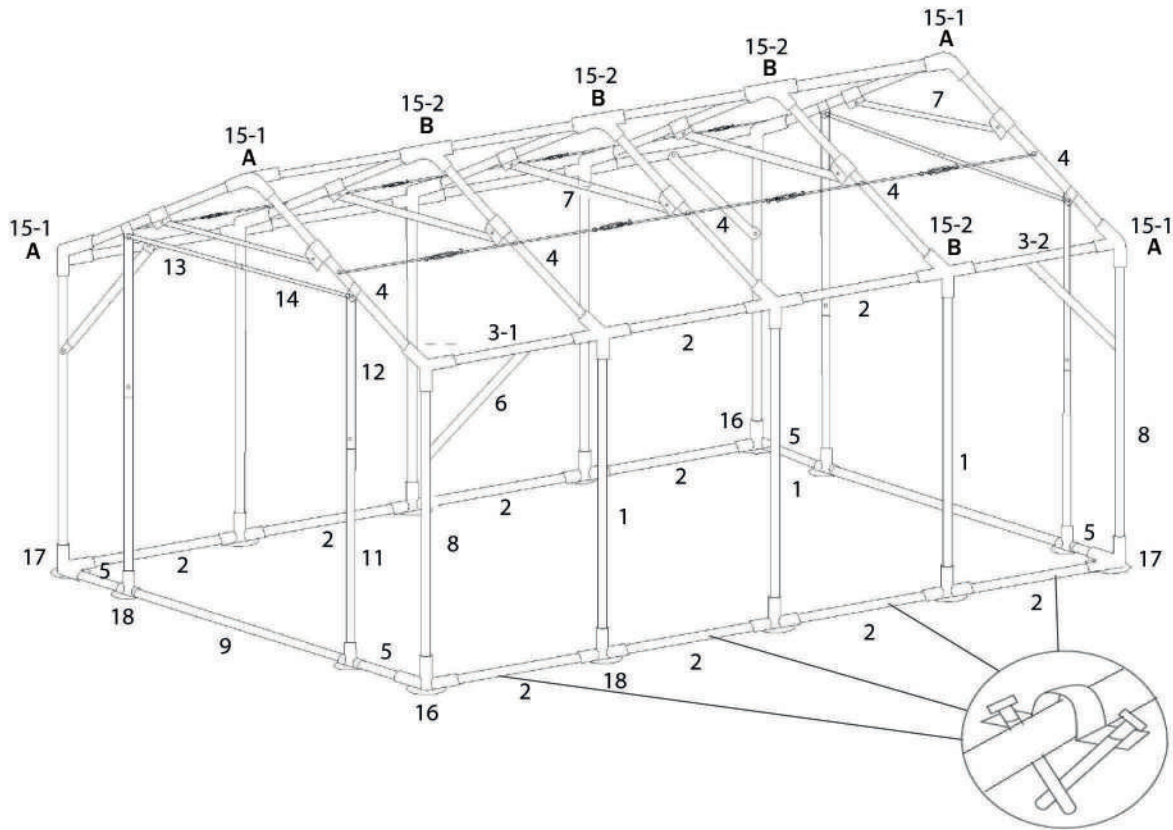

#### V

You facilitate the assembly and dismantling by pulling the roof with ropes onto tent frame. Use the steel clips to fasten the cover to the frame. Each section we offer bracket and nail to fasten the frame to ground.

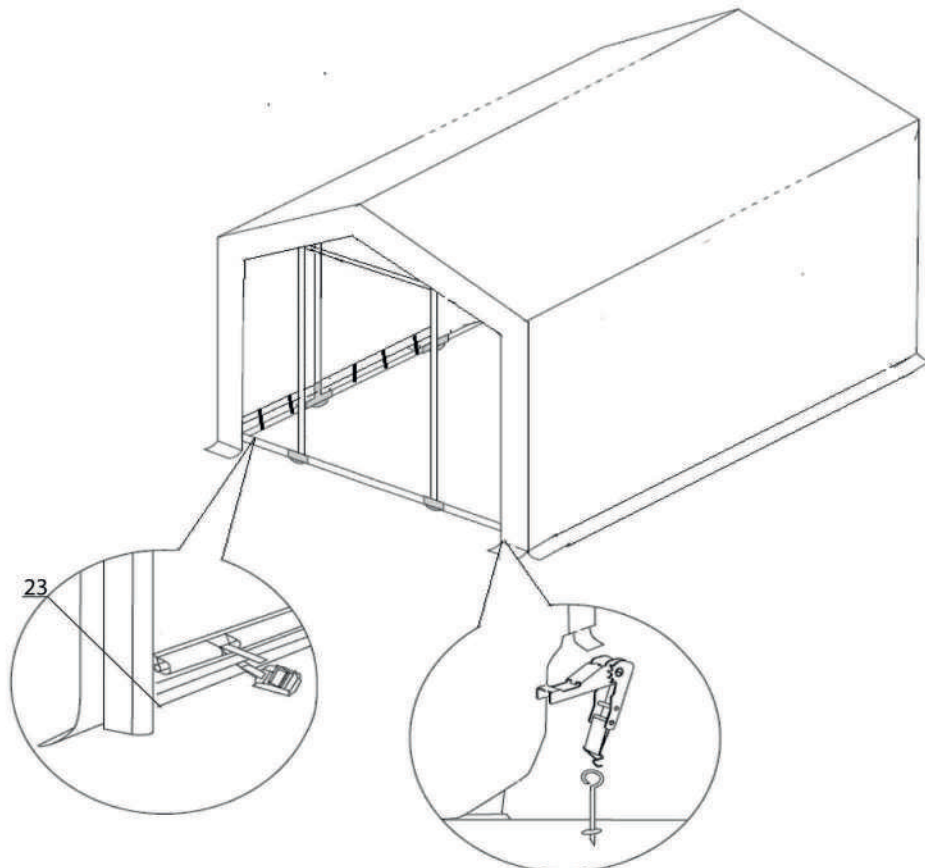

VI

Spread the wall panel and door panel attach to framework by using the bungee cords clasping the frame to grommets that is construct over the wall panel and door panel to ensure stability. Also use the short pegs to fix the doors to the ground.

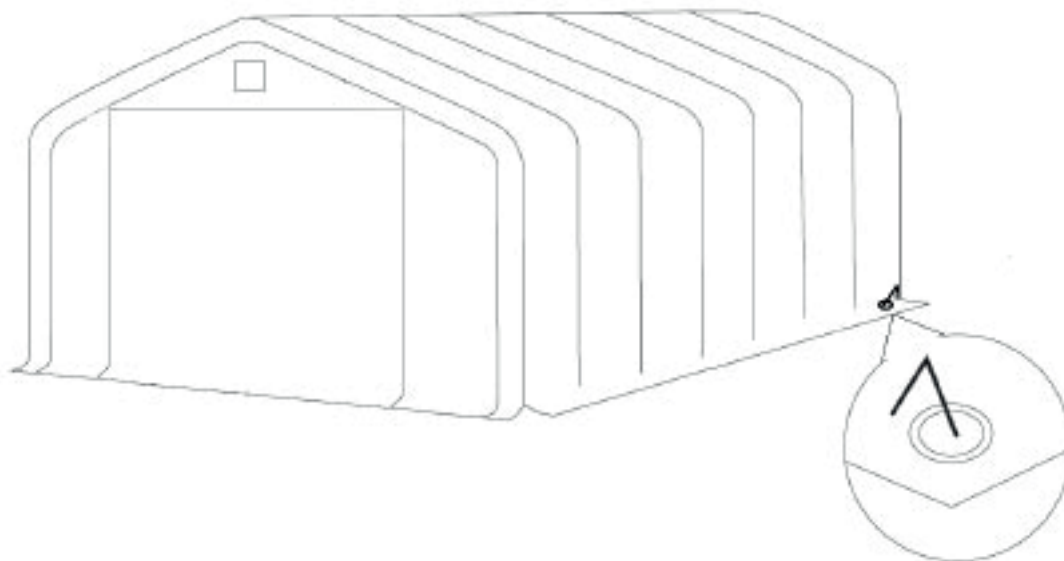

# DANCOVER<sup>®</sup>

.com

## Contact information

### Head office:

Dancover A/S  
Nordre Strandvej 119 G  
3150 Hellebæk  
Denmark

For more information  
please visit:  
[www.dancovershop.com](http://www.dancovershop.com)

## National contact

Denmark: 70 26 76 20  
[denmark@dancover.com](mailto:denmark@dancover.com)

UK: 020 8099 7570  
[uk@dancover.com](mailto:uk@dancover.com)

Germany: 041 0266 7040  
[germany@dancover.com](mailto:germany@dancover.com)

France: 0975 181 800  
[france@dancover.com](mailto:france@dancover.com)

Sweden: 040 233 262  
[sverige@dancover.com](mailto:sverige@dancover.com)

Finland: 0 931 581 720  
[suomi@dancover.com](mailto:suomi@dancover.com)

Poland: 22 300 8602  
[polska@dancover.com](mailto:polska@dancover.com)

Luxembourg: +49 041 0266 7040  
[luxembourg@dancover.com](mailto:luxembourg@dancover.com)

Portugal: 308 800 899  
[portugal@dancover.com](mailto:portugal@dancover.com)

Spain: 911 436 828  
[espana@dancover.com](mailto:espana@dancover.com)

Italy: 02 479 21 198  
[italia@dancover.com](mailto:italia@dancover.com)

Switzerland: 0840 000125  
[schweiz@dancover.com](mailto:schweiz@dancover.com)

Austria: 0662 626935  
[austria@dancover.com](mailto:austria@dancover.com)

Norway: 231 00 690  
[norge@dancover.com](mailto:norge@dancover.com)

Nederland: 0 858 880 524  
[nederland@dancover.com](mailto:nederland@dancover.com)

Ireland: 0 151 33 003  
[ireland@dancover.com](mailto:ireland@dancover.com)

Belgium: 0 28 08 08 09  
[belgique@dancover.com](mailto:belgique@dancover.com)