

DANCOVER[®]

.com

Manual

Boat tent Oceancover PVC

5,5x15x4,1x5,3m

DANCOVER[®]



Safety Advice

Attention

In some countries approval is needed to set up a marquee/tent larger than 75 m². It is your responsibility to comply with local rules and regulations and to ensure that the marquee/tent is assembled correctly.

In case of bad weather conditions, it is your responsibility to ensure the marquee/tent is safely secured and that the marquee/tent does not cause damage to others.

Do not use open fire, welding equipment or other sources which can ignite, inside or close to the tent.

The marquee/tent must be safely secured. We recommend you secure your marquee/tent with straps and pegs as soon as it is assembled.

Make sure to check if the marquee/tent is covered by your home contents insurance.

Marquees/tents must be evacuated under extreme weather conditions.

In the event of snow always remove snow from the roof of the marquee/tent regularly to prevent snow from building on the roof as heavy snow can cause the marquee/tent to collapse.

In the event of rain there is a risk of rain puddles building up on top of the roof of the marquee/tent. Heavy rain puddles can cause the roof to collapse. It is your responsibility to ensure rain puddles do not build up. As a precaution, make sure the roof of the marquee/tent is stretched out properly and adequately over the side frames of the marquee/tent and remove rain water regularly.

Do not unpack or repack your marquee/tent in freezing temperatures. In case of temperatures below zero always unpack and repack your marquee/tent indoors to avoid the risk of cracking parts.

The marquee/tent must be totally dry before you repack and store it to avoid mildew.

This structure is not tested for snow and wind loads. We always recommend that you remove snow from the roof. This is a none-permanent structure.

Warranty Information

Please visit dancovershop.com for information on warranty.

Please always check our website for the latest safety advice and manual.

Congratulations on your purchase of our instant shelter. This unit is a combination of excellent manufacturing and design. It is comprised of a rigid frame and a durable cover. For easy assembly, we have marked all the parts with codes, with proper installation, use and maintenance, your unit will provide many years of good and suitable service.

Tools required

The following hand tool will be needed for proper Installation of your new building:

12mm,14mm, and 17mm Open End Wrenches,

12mm, 14mm, 17mm Sockets or Box Wrench,

Large Flat Head Screwdriver,

2lb maul or Sledgehammer

4 Foot Level 14' Step Ladder

Stake &String for aligning Base Plates &Frame

Assembly procedure

1. Prepare location and place all unit boxes near location sight. Perform an inventory check before beginning, to be certain all components are available for installation.
2. Secure base plate flanges to base surface.
3. Assemble every group of arch.
4. Begin frame assembly with front end arch, first interior arch, purlins, etc.
5. Add to assemble other groups of arches.
6. Install main cover over frame.
7. Install end cover over end panels.

Read all the detailed instructions and notices in the following assembly instructions!

Maintenance and care

Annually or more often, the unit should be completely inspected internally and externally to make certain the unit remains properly installed and secured .Particular attention should be paid to:

Hardware-check all carriage bolts and hardware connectors to be certain they are in place and tightened.

Weather trends, the unit will strain against the base plate flange under windy conditions, pegs hardware, connection to frame members should be maintained tight and depth of pegs should be checked to be certain they remain deeply and firmly set.















Snow Accumulation -All snow accumulation on the main cover should be removed as soon as possible. Tap the main cover from the inside with a broom or soft brush to clear cover.

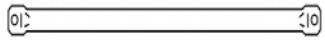



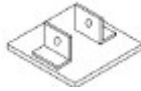

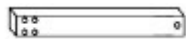





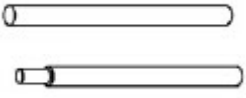

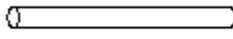

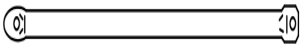

Main Cover Lacing-the poly rope that secures the main cover to the bottom rail of the frame assembly should be checked, and adjusted as needed. The tension on the main cover should be uniform from end and side to side. Rope ends must be tied off onto the frame members at the ends on each side.







Cleaning -cover and doors can be cleaned with a mixture of light detergent and water. A soft bristle brush with the mixture can be used to loosen any hard dirt, mold, or buildup on the cover. After cleansing, the cover should be rinsed thoroughly to avoid any chemical reaction from residual detergent. Allowing dirt and debris to sit on cover over an extended time will damage cover irreparably.

Severe Weather-in preparation for inclement weather, completely secure the door of your buildings portable building. Allowing wind to enter end lifts the

Thanks again for choosing this quality product. The following is the detailed assembly instructions for you starting the assembly.

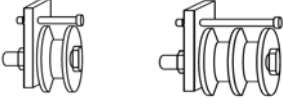
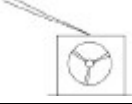
5,5x15x4,1x5,3 part list			
Part code	Description		Qty
1	Curved roof tube		7
2	Curved side roof tube		10
2A	Curved side roof tube in front and back panel		4
3	Sidewall Tubes		10
3A	Sidewall Tube of front and back panel		2
3B	Sidewall Tube at right of front and back panel to connect the winch rail		2
4	Horizontal wall and roof purlin		30
5L	Base flange in corner		2
5R	Base flange in corner		2
6L	Base flange for sidewall		5
6R	Base flange for sidewall		5
7	Base flange of door frame		4
8	Beam beside door frame		4
9	Door beam		2sets
10	Upper door track		4
11	Lower door track		2

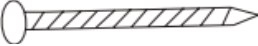
11A	Lower door track for bottom rail		2
12	Bottom rail for winch of mechanical door(beside the door)		2
13	Cover Tensioning tube for roof cover		2sets
14	Door dropping tube		12sets
15	Door dropping tube at the bottom		2sets
16	Cover tensioning tube of front and back cover		4
17	Wind Brace Support		4
17A	The tube clip for wind brace support		8
18	Hexagon bolt M10x90		100
19	Carriage bolt M10x100		40
20	Hexagon bolt M10x30		18
21	Hexagon bolt M10x75		40
21A	Hexagon bolt M10x85		22
22	Hexagon bolt M10x12 Already installed on Part 23		28
23	Tie down ratchet		14
24	Band for tie down ratchet		14
25	Roof cover		1
26	Side cover beside the door(without window for the winch of door)		4

27	Top cover above the door		2
28	Door cover		2
29	Single and Double Pulley		2sets
30	Winch		2
31	Rope for fastening the roof cover, the door cover and the front&back cover		18
40	Stake peg		50
42	Plastic cap of tensioning tube		12
43	Turnbuckle and steel wire		8sets

05-03-2015-QJ

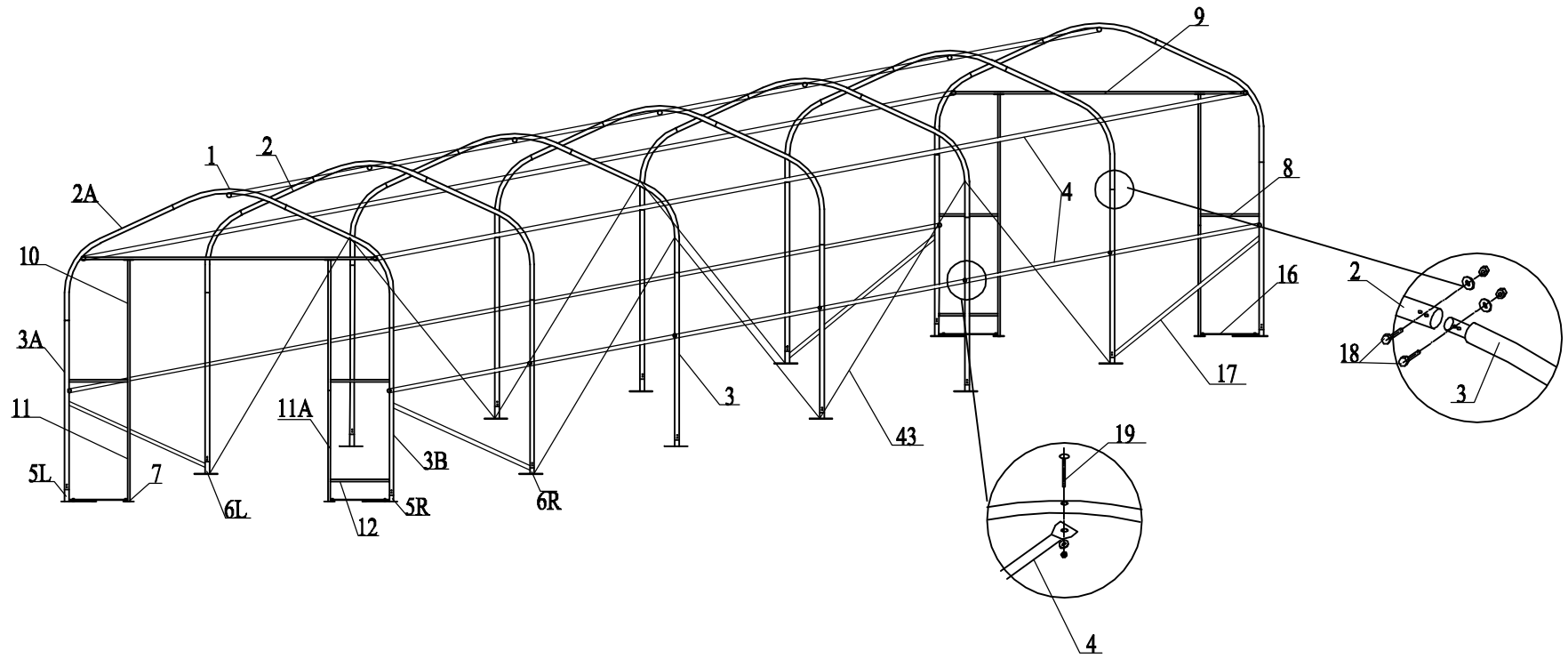

Figure 1

Sketch of Model 185017 Size: W5.5*L15*H5.3M

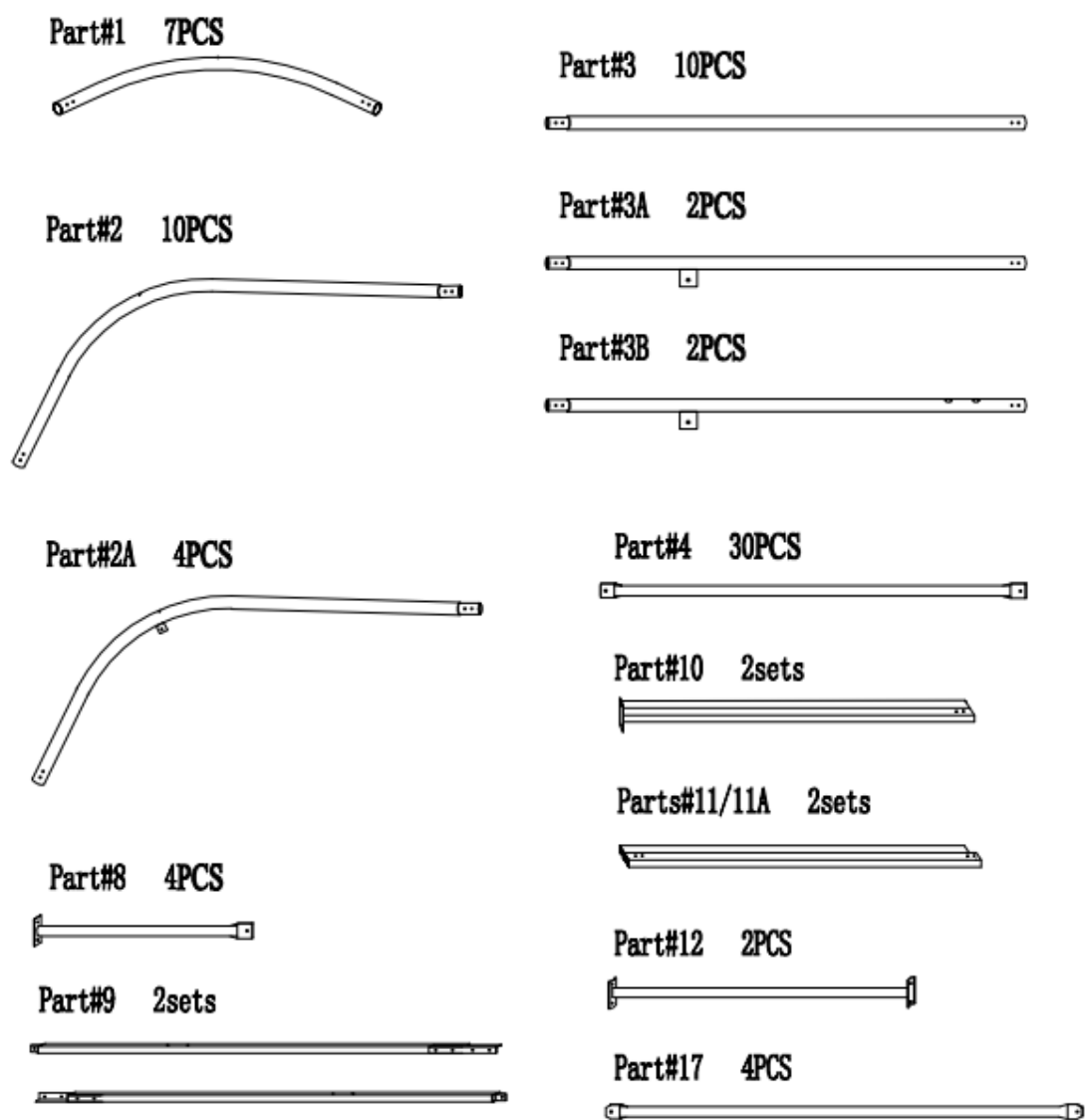

Figure 2 Sketch of parts

Step #1 --SECURING BASE FLANGES

Sit the building boxes in the chosen location. Remove all the components from packaging to ensure all components are present by checking with the Part List.

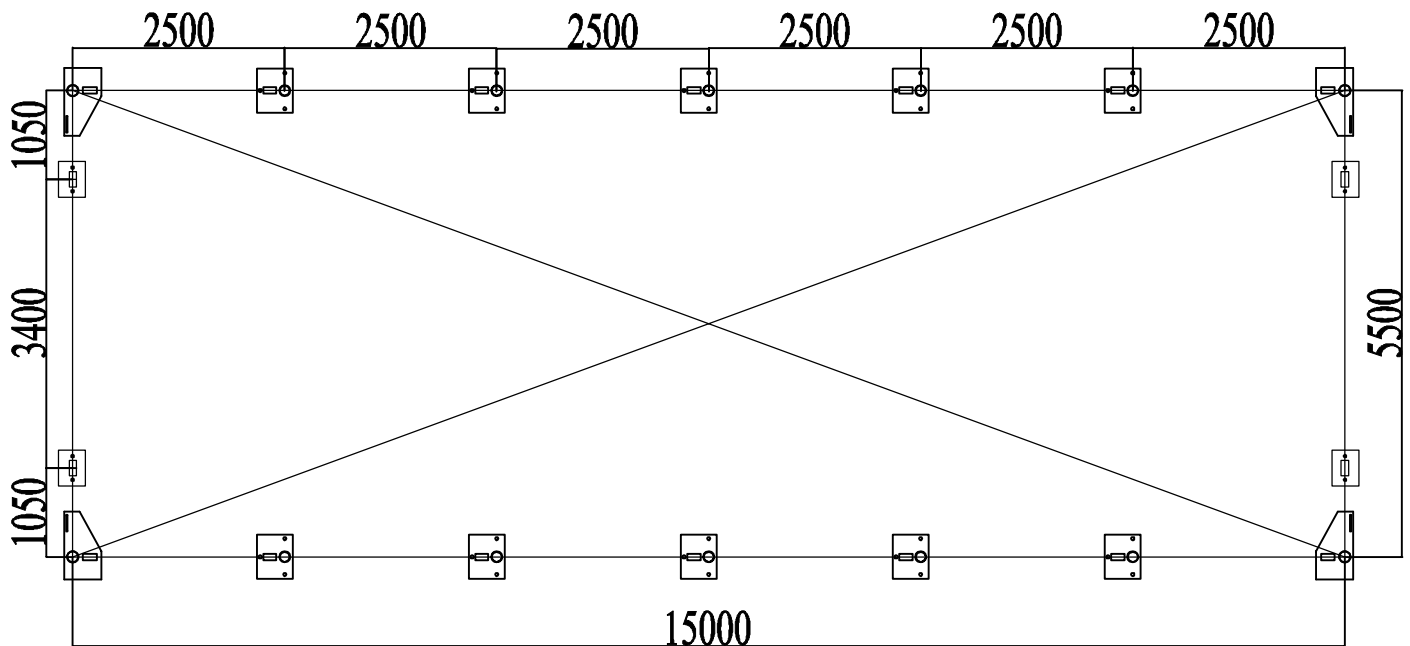

Figure 3 Position of Base Flanges

Begin by determining exact location of the four (4) corners of the building. Mark front edge and side-to-side width of assembly on ground. Drive alignment stakes into the ground outside of the markings, and draw alignment strings along both ends and sides of the building to the dimensions shown in Figure 3. The outline of the strings will represent the final location of the base flanges. The initial location of each Corner Base Flanges (5R & 5L) is critical to the alignment and fit of the frame components and cover.

Locate the Left Corner Base Flange and Right Corner Base Flange(5R&5L). Secure the base flanges with Stake Pegs (Part #17). Measurements shown in Figure 2 are to the center of the upright sockets on each Base Flange.

The Shelter must be secured to a firm surface that can receive and retain augers and pegs firmly in position. The shelter should be installed on FIRM GROUND, not on SWAMP, SOFT/WET GROUND. The Base Flanges must be secured so they cannot be moved. Arches are tensioned at their base as they insert into the Base Plate sockets.

Step #2 --ARCH ASSEMBLY

Assemble each arch on ground. Each arches consist of:

One curving roof tube (Part #1)

Two roof curving tube (Part #2/2A)

Two curving sidewall tube (Part # 3/3A/3B)

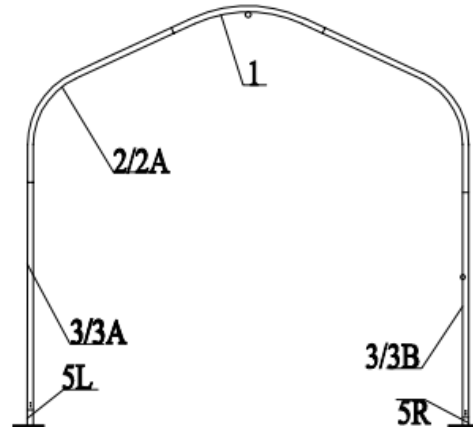

Figure 4 the arch installation

Connect the arches by Using the hexagon bolts with washers and nuts through predrilled holes in frame members. Do not tighten down the nuts completely until frame is fully assembled and set in place.

THE FRONT PANEL FRAME ASSEMBLY

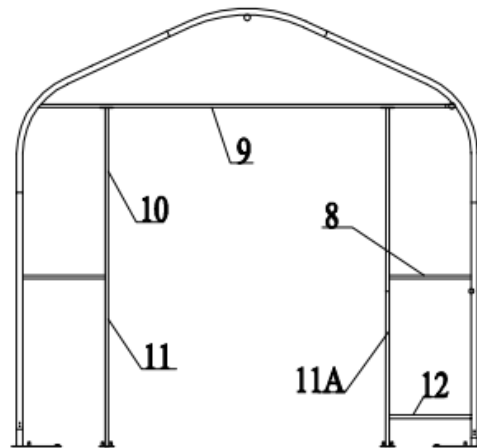

Figure 5 Frame Installation for Front Panel

Assemble the front panel frame. According to Figure 5, connect the end wall frame by Using the bolts with washers and nuts through predrilled holes in frame members. Do not tighten down the nuts completely until frame is fully assembled and set in place.

NOTE: Please notice that the part code of the arch sections.

The sections of different arches are not the same.

Check with the Part List and the Sketch Figure #1.

Step #3 --ERECTING ARCHES

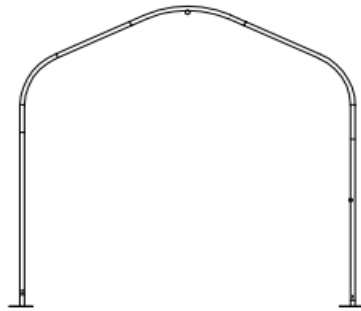

Figure 6 Attaching Arches to Base Flanges

Begin frame assembly by erecting Front Arch into Front Corner Base Flanges. Place left frame sidewall tubing into the upright tube socket into the Left Base Flange. Place Hexagonal Bolt through base flange socket and arch sidewall tube hole.

In order to insert Right Sidewall Tube into Right Front Corner flange, it is necessary to support arch on left side to prevent movement. Position the Right Sidewall Tube over the Right Corner Base Flange.

Once the Right Sidewall Tube is placed into right corner base flange, insert a hexagonal bolt and nut to prevent it from popping out of the socket while assembly continues.

Next stand first interior arch up to repeat insertion into Base flanges.

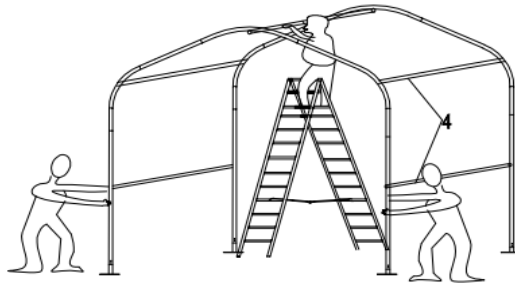

Figure 7

Immediately after putting first interior arch into place, connect Front Arch and Interior arch using Roof Purlin Tubes at top ridge and side shoulder curves of arches. Secure the Roof Purlin tubes into place using carriage bolts and nuts.

Next install the Wind Brace supports(part#13) and Tube Clip(part#13A) that connect the Front Arch to the first Interior Arch. The Wind Braces give the arch assemblies strength as a unit. Use Bolt M10X30 at the end of each Wind Brace Support to secure. Continue to install other Arches Assemblies in the same manner. Overlap pinched ends of Roof Purlin onto same carriage bolts inside frame assembly.

Next check entire frame assembly for square and plumb. Next tighten frame bolts adequately. **DO NOT** over tighten bolts so as to oval or compress frame components. .

Step #4 --POSITION ROOF COVER

As figure 8 shows, when ready to install Roof Cover, unpack cover and lay parallel to building frame on one side. Cover must be pulled over top of frame assembly without being snagged or stressed on any frame members. Use multiple ropes over top of frame as shown in picture below. Having another person inside frame on a ladder to assist in getting Roof Cover over frame will insure the cover will go on without any damage.

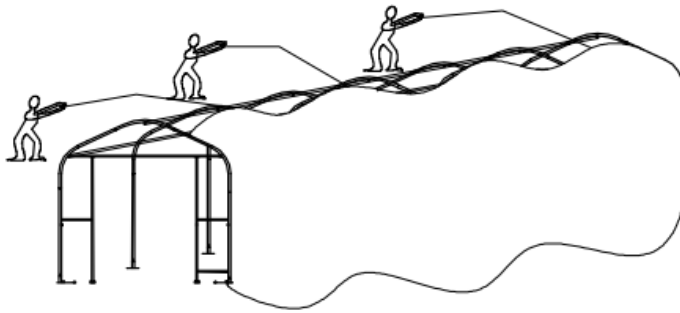
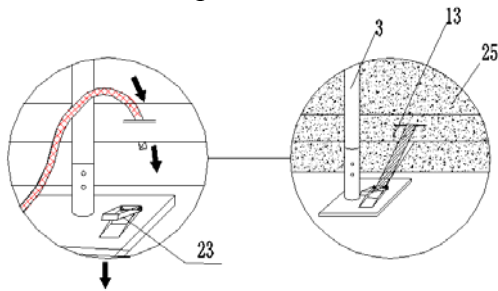

Figure8: Pull the Roof Cover over the frame evenly

First circle the band for tie down ratchet(part#23) around the tensioning tube through the cuts on the pocket of the roof cover.



Then put the bands through the reel of the ratchet.

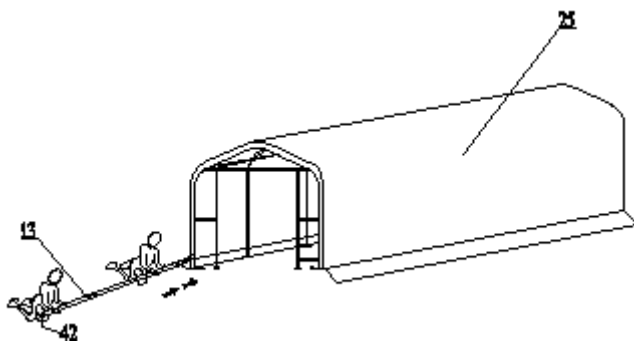
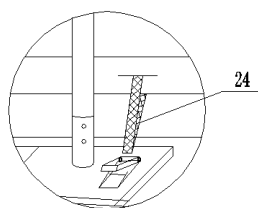

Figure 9 Fastening the Roof Cover

Step #5 --TENSION COVER ON FRAME FROM SIDE-TO-SIDE

As Figure 9 shows, when Roof Cover is over top of Frame Assembly, insert Cover Tensioning Tubes into pockets along both sides of Roof Cover. Centre Roof Cover over Frame assembly both side to side and front to back. Align one side of Roof Cover evenly front to back. Add Band for Tie Down Ratchet at each point along the cover opening, as shown. Put Band for Tie Down Ratchets over Cover Tensioning Tubes at each Base Plate along one side. Bands do not attach to Tensioning Tubes, but loop around and secure at both ends on ratchet.

Next take up slack in tie bands by ratcheting the mechanisms, tightening cover. Evenly adjust ratchets on both sides of roof cover to take wrinkles out of roof cover. **DO NOT** fully tighten cover yet. Leave adequate slack so that cover can also be adjusted front to back in next step.

Step #6 --TIGHTEN ROOF COVER ON FRAME FRONT TO

BACK

The roof cover is tensioned from front to back by the rope lacing to grommet flaps inside the main cover, inside the unit at both front and rear arches. Using the rope provided, lace the main cover grommet flap around the main frame front and rear arch pieces. Start in the top middle of each arch, and lace to each side. Add rope length by tying pieces together or cutting as necessary.

Lace all grommets on cover inside flap with rope. Starting at the middle top point over the door, tighten lacing only enough to take wrinkles out of the cover. Repeat for the Rear Arch. **DO NOT** over tighten lacing to pull out the grommets.

After the roof cover lacing is adjusted evenly across the grommet flap, go back and re-adjust the Tensioning Ratchets along the side edges of the Roof Cover. At this point, the main cover can be pulled taut enough to take all excess material and wrinkles out of cover. It will be necessary to repeat this step 2-3 weeks after unit assembly is complete and roof over has a chance to stretch out over the frame completely.

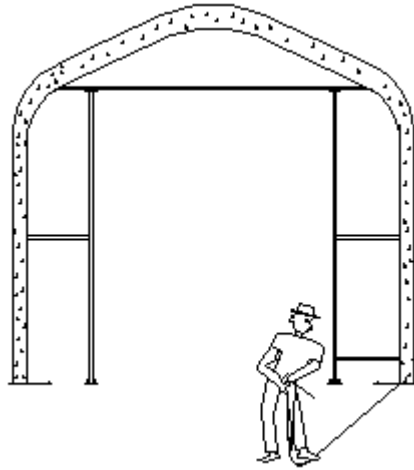

Figure 10 Fastening the two ends of the Roof Cover

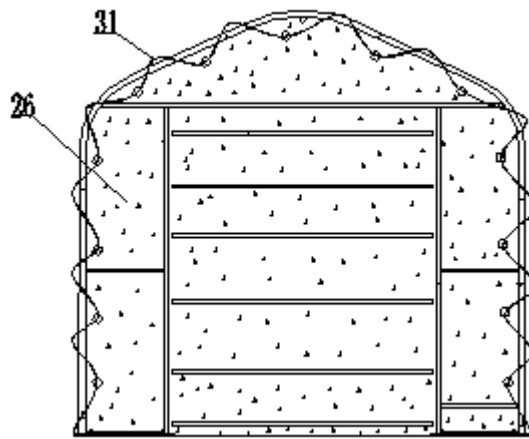

Figure 11 Fastening the two ends of the Roof Cover

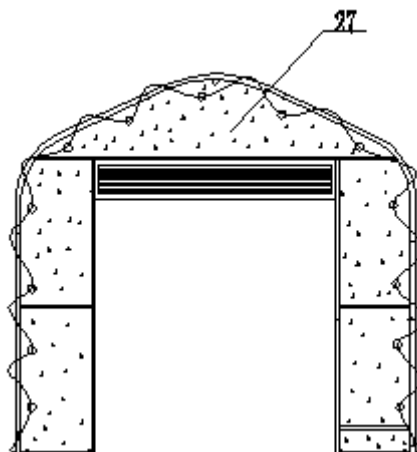

Figure 12 Open Door Cover

Installation of mechanical door
assembly
(Seeing from inside)

The door dropping tube

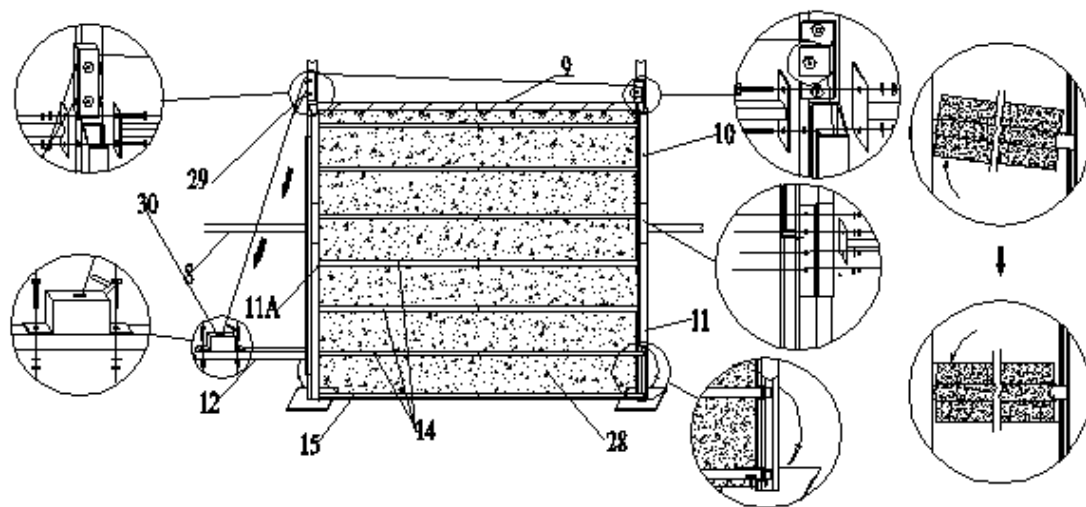

Figure 13 Installation of the Mechanical Door

Step #9 --MECHANICAL DOOR INSTALLATION STEPS

1. Install Main Door Pulleys (left and right) over the Top of the Door on each side of the Door Beam (Part #9).
2. Next mount the Winch Mechanism to the Front Panel Lower Beam (Part #12).
3. Slide Bottom Door Dropping Tube (Part #15) into the bottom horizontal fabric pocket on the Door Cover (Part #28). Then slide the six remaining Door Dropping Tubes (Part #14) into the remaining horizontal fabric pockets in the Door Cover.
4. Raise the Bottom Dropping Tube (#15) to the top of the Upper Door Tracks. Put the Bottom Dropping Tube (#15) into the tracks side to side so the ends start down the tracks. Gently allow the Door Cover to go down, and feed the six remaining Door Dropping Tubes (#14) into the Door Tracks.
5. Next install the steel wire that leads from the bottom of the door dropping tubes to the door winching assembly. Take one of the Steel Wires in the Door kit, and feed down from the top of the Door track to the Bottom Door Tube Dropping Tube (#15) on the right hand side of the door (facing from the inside). When the steel wire goes down though the hole in the Bottom Dropping Tube, tie a knot in the steel wire so that it cannot pass back up through the hole.
6. From the Winch Assembly route leading end of the Longer Steel Cable through the Upper Roller of the double the pulley near door track and then through the Single Roller on the door track farthest from the Winch Assembly. Then down through the Bottom Door Dropping Tube (15). When the steel cable goes down though the hole in the Bottom Door Dropping Tube, tie a knot in the steel cable. Door can now be operating the Winch Assembly. Raise and lower the door several times to be certain door tube ends are not binding on track.. Lubricate if necessary.

Contact information

Head office:

Dancover A/S
Nordre Strandvej 119 G
3150 Hellebæk
Denmark

For more information
please visit:
www.dancovershop.com

National contact

Denmark: 70 26 76 20
denmark@dancover.com

UK: 020 8099 7570
uk@dancover.com

Germany: 041 0266 7040
germany@dancover.com

France: 0975 181 800
france@dancover.com

Sweden: 040 233 262
sverige@dancover.com

Finland: 0 931 581 720
suomi@dancover.com

Poland: 22 300 8602
polska@dancover.com

Luxembourg: +49 041 0266 7040
luxembourg@dancover.com

Portugal: 308 800 899
portugal@dancover.com

Spain: 911 436 828
espana@dancover.com

Italy: 02 479 21 198
italia@dancover.com

Switzerland: 0840 000125
schweiz@dancover.com

Austria: 0662 626935
austria@dancover.com

Norway: 231 00 690
norge@dancover.com

Nederland: 0 858 880 524
nederland@dancover.com

Ireland: 0 151 33 003
ireland@dancover.com

Belgium: 0 28 08 08 09
belgique@dancover.com