

Assembly Manual / Guide d'assemblage / Manual de ensamblaje / Montageanleitung

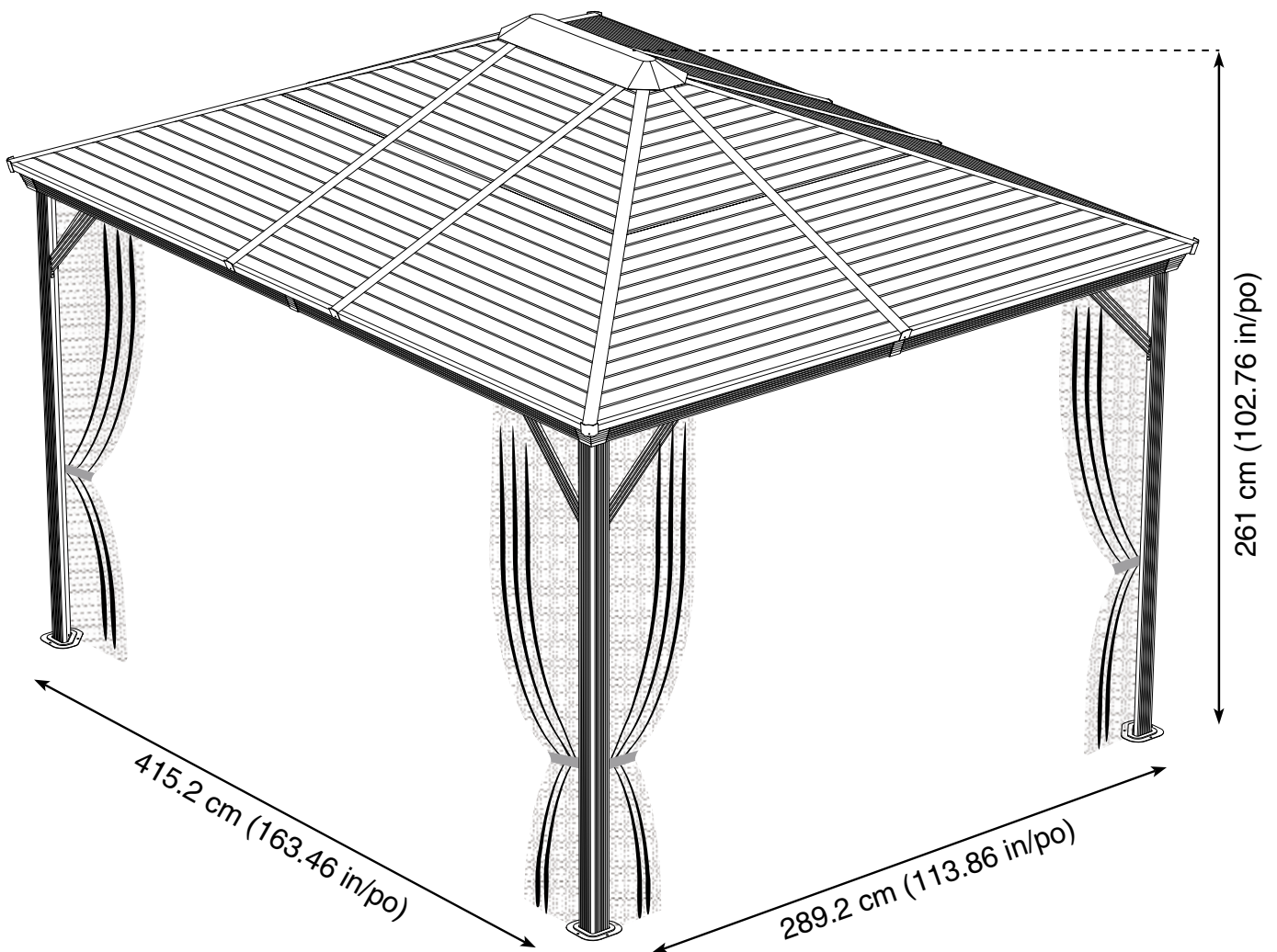

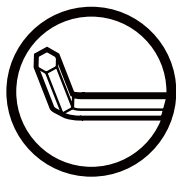

Use the hex keys in the box. / Utilisez les clés hexagonales fournies dans la boîte. / Utilice las llaves hexagonales en la caja. / Verwenden Sie die Sechskantschlüssel in der Box.

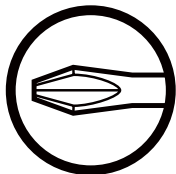

Please use a Phillips screwdriver. / Utilisez un tournevis de type Phillips / Por favor, use un destornillador Phillips. / Bitte verwenden Sie einen Kreuzschraubenzieher.

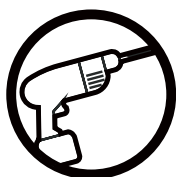

You may need to use a drill for this step. / Vous pouvez avoir besoin d'utiliser une perceuse pour cette étape. / Puede que tenga que utilizar un taladro para este paso. / Für diesen Schritt können Sie einen Bohrer verwenden.



Wearing protective gloves is recommended. / Le port de gants de protection est recommandé / El uso de guantes de protección se recomienda. / Das Tragen von Schutzhandschuhen wird empfohlen.



Two or more people are required at this stage. / Deux personnes ou plus sont nécessaires à cette étape. / Dos o más personas se requieren en esta etapa. / Für diesen Bauschritt sind 2 oder mehr Personen erforderlich.



Do not tighten screws all the way for now. / Ne pas visser fermement pour l'instant. / No atornille con firmeza por ahora. / Bitte die Schrauben zum jetzigen Zeitpunkt noch nicht fest anziehen.

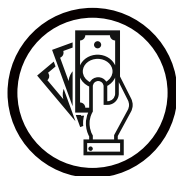

Sold separately. / Vendus séparément. / vendido en las opciones. / Optional erhältlich



Optional step / Étape optionnelle / Paso opcional / Optionaler Schritt

T X 8 (+2)

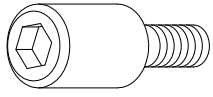

U X 16 (+2)

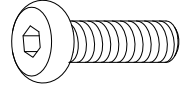

U1 X 40 (+8)

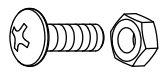

U2 X 2 (+1)

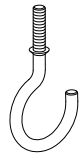

U3 X 1 (+1)

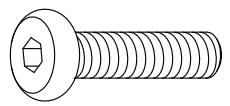

V X 92 (+10)

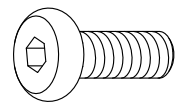

V1 X 16 (+2)

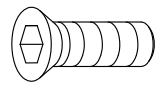

V2 X 20 (+2)

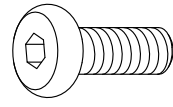

W X 34 (+4)

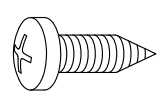

W1 X 16 (+2)

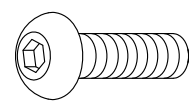

Y X 1

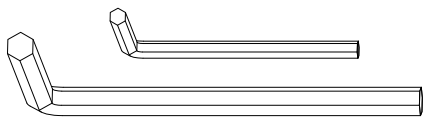

Y1 X 44 (+4)

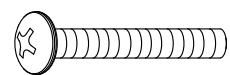

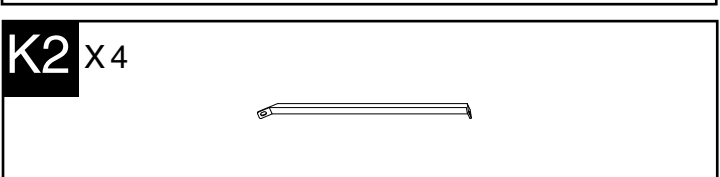
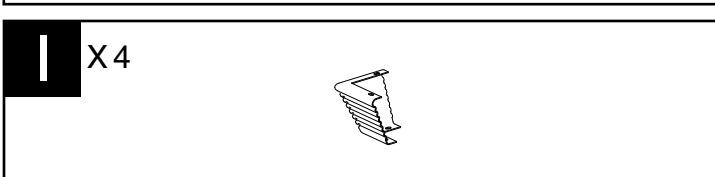
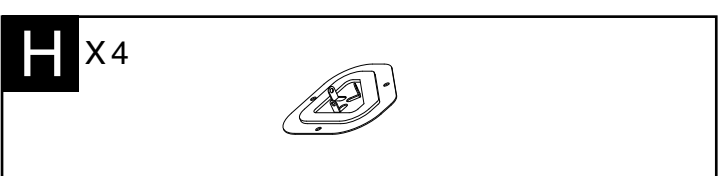
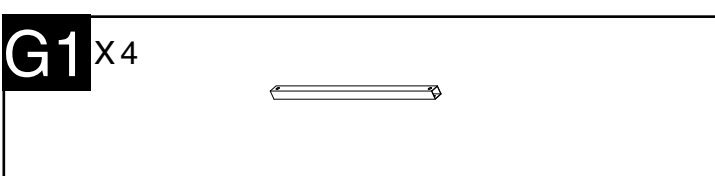
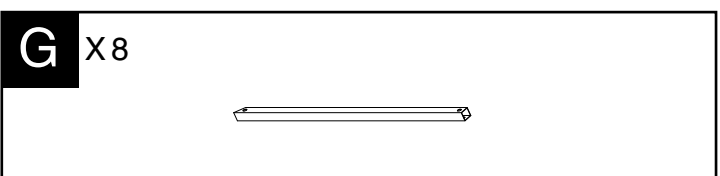
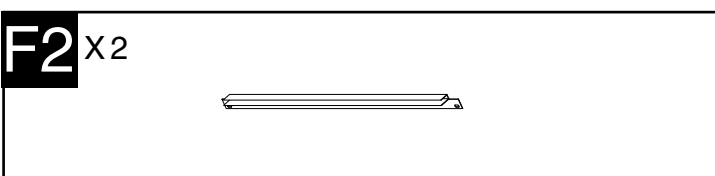
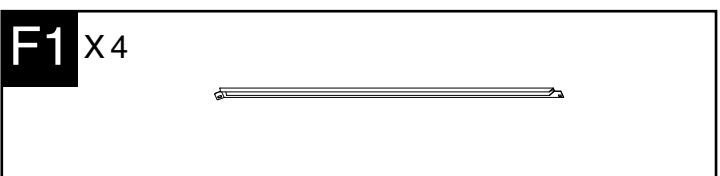
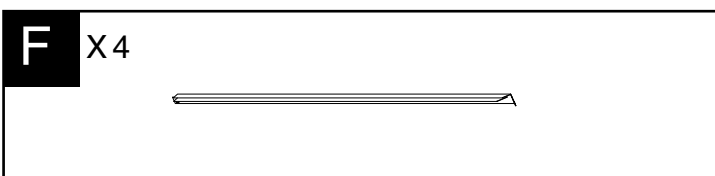
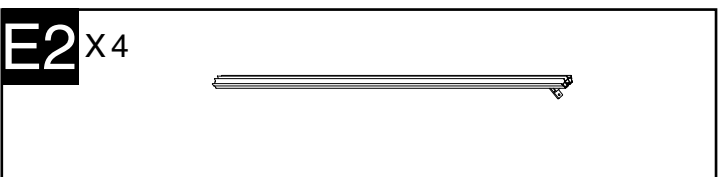
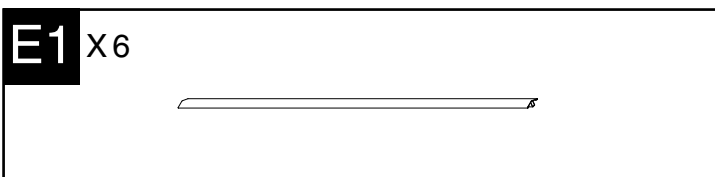
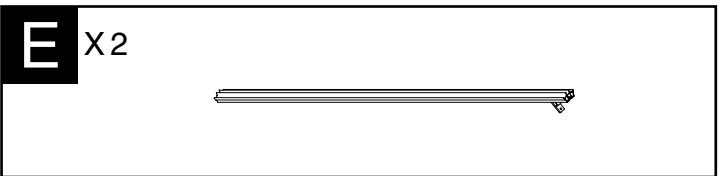
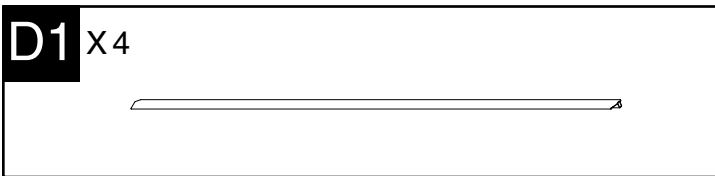
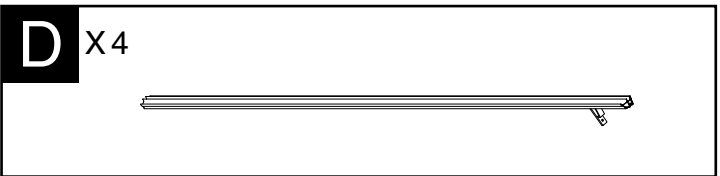
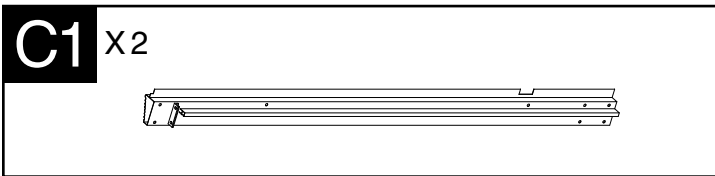
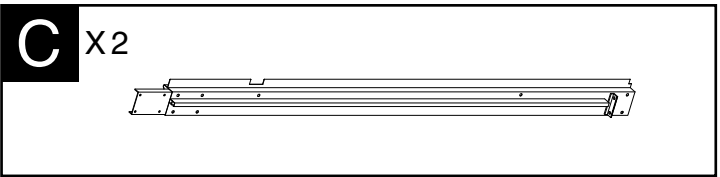
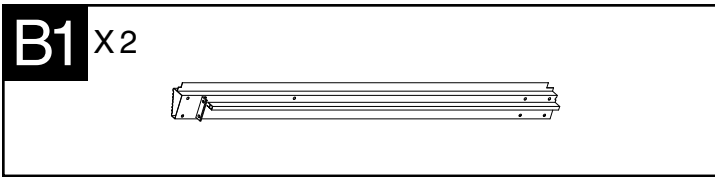
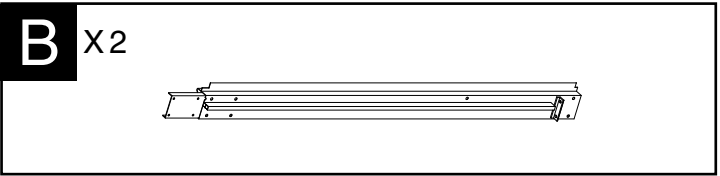

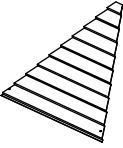
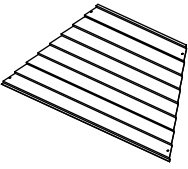
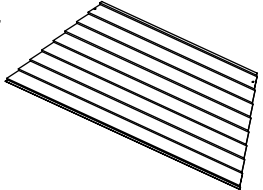

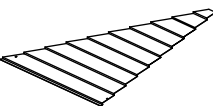
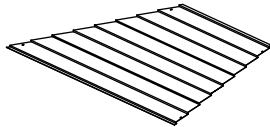
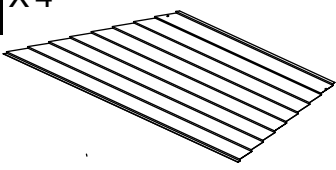

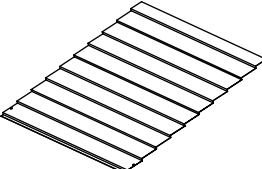
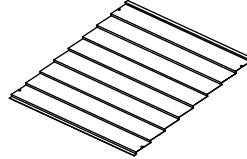

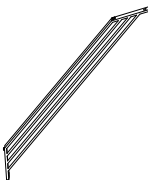
N X4 	N1 X4 	N2 X4 
--	---	---



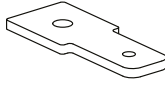

O X4 	O1 X4 	O2 X4 
--	---	---



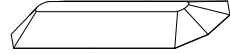

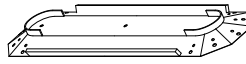
P X2 	P1 X4 
--	--

K X8 	L X4 
---	---

M2 X4 	M3 X6 	M4 X4 
---	---	---

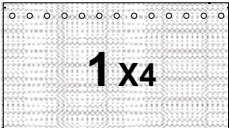
Q X4 	R X6 	S X1 
--	--	--

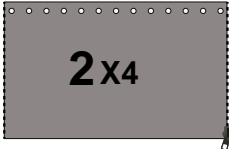
S1 X1 	X X56 optional 		X X56 optional 
---	--	---	--

Net  1 x4	 optional	Curtain  2 x4	 optional
--	---	--	---

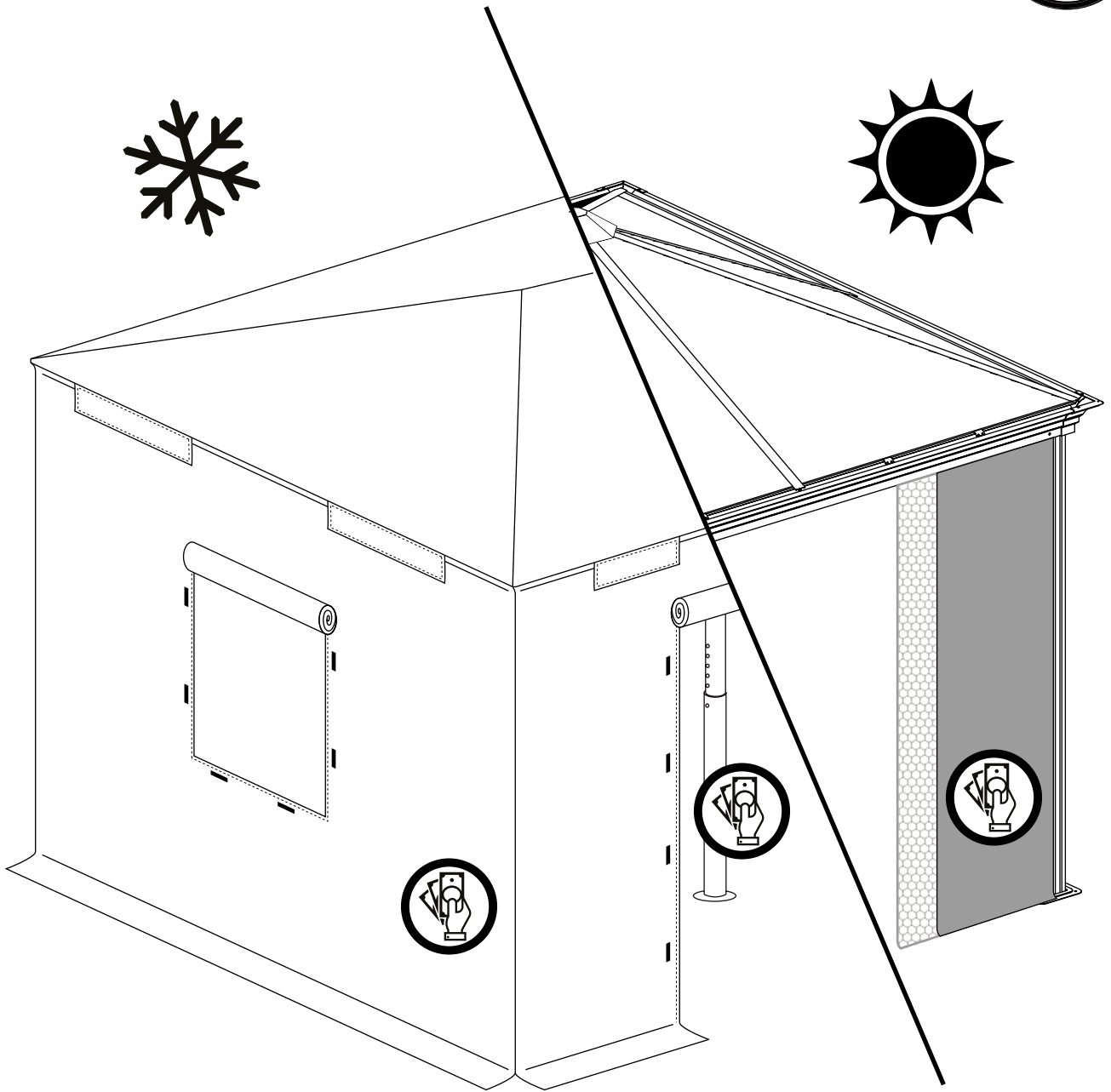
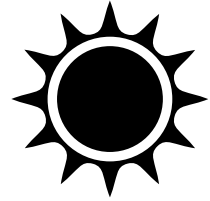
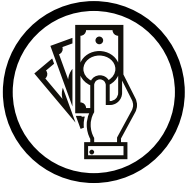

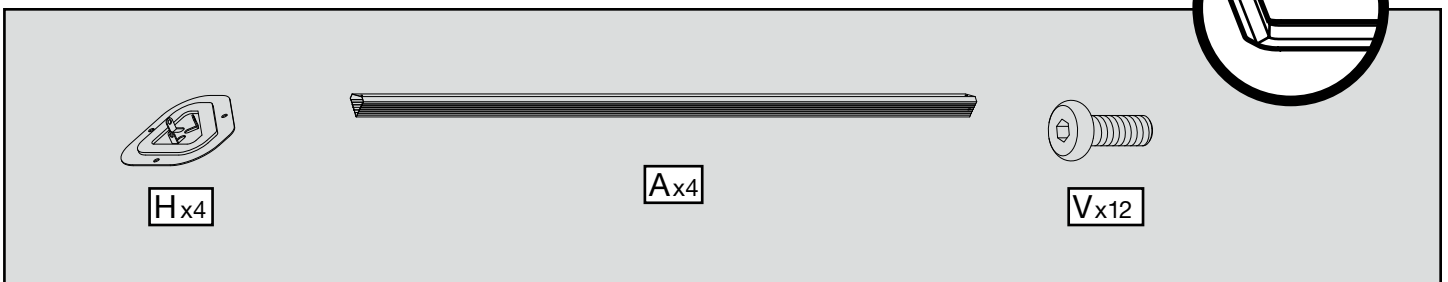
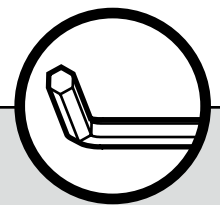
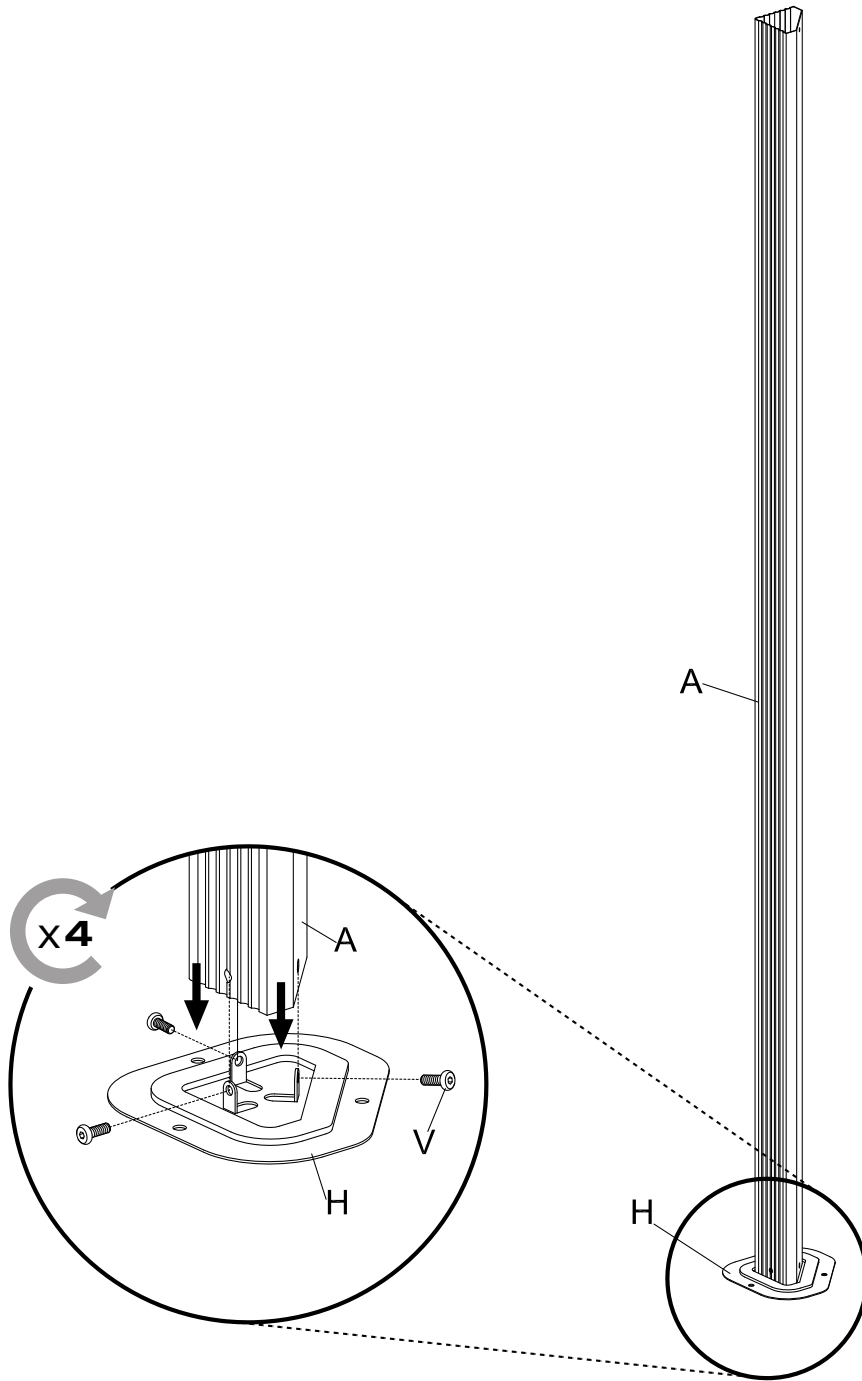

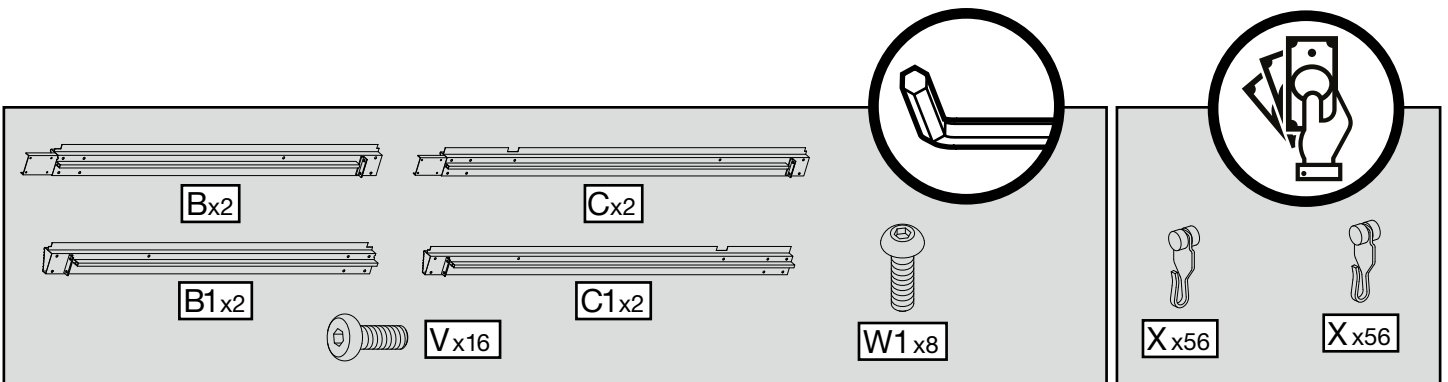
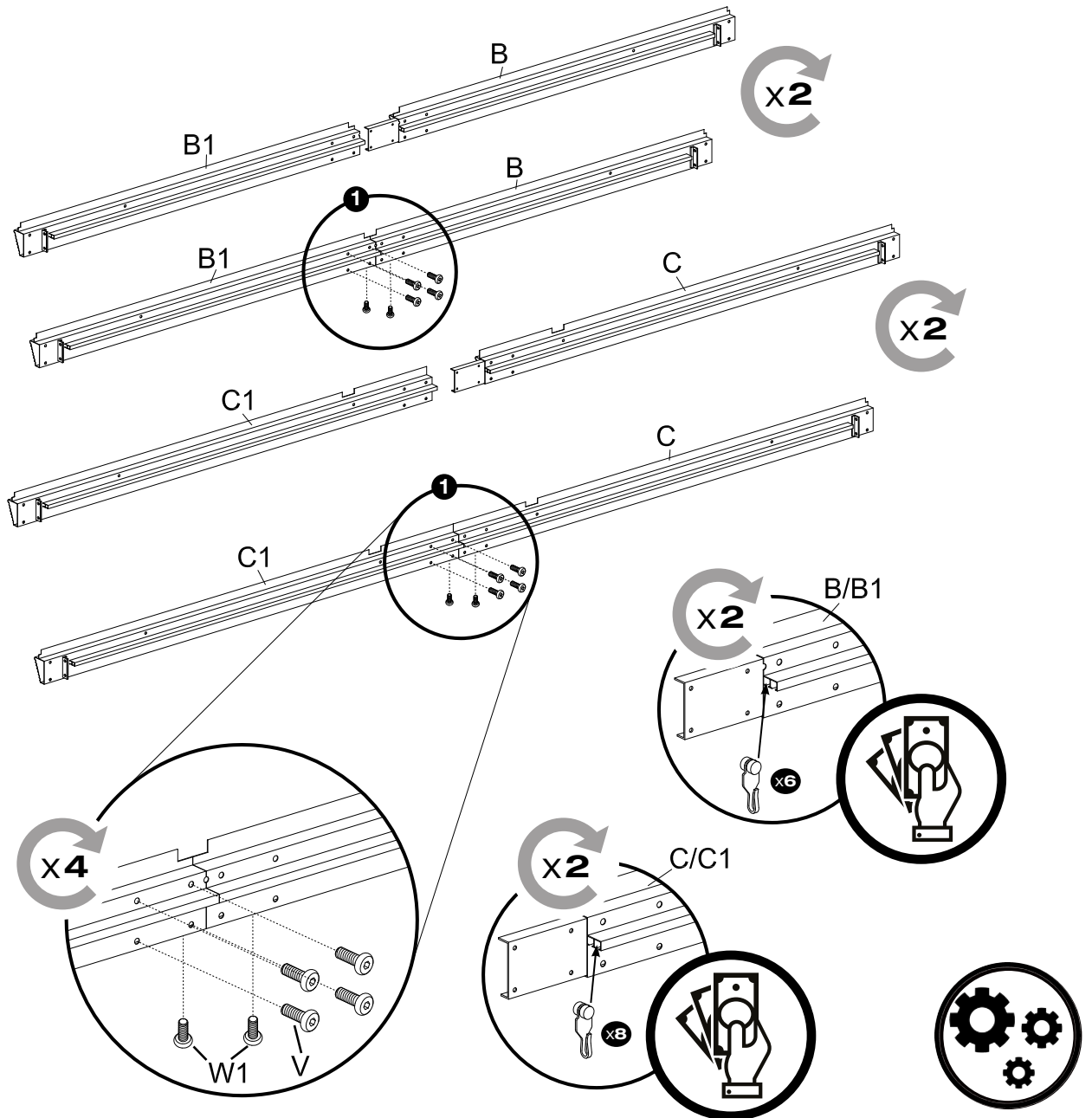

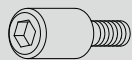
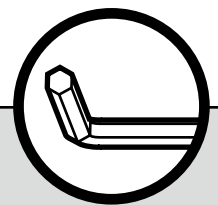
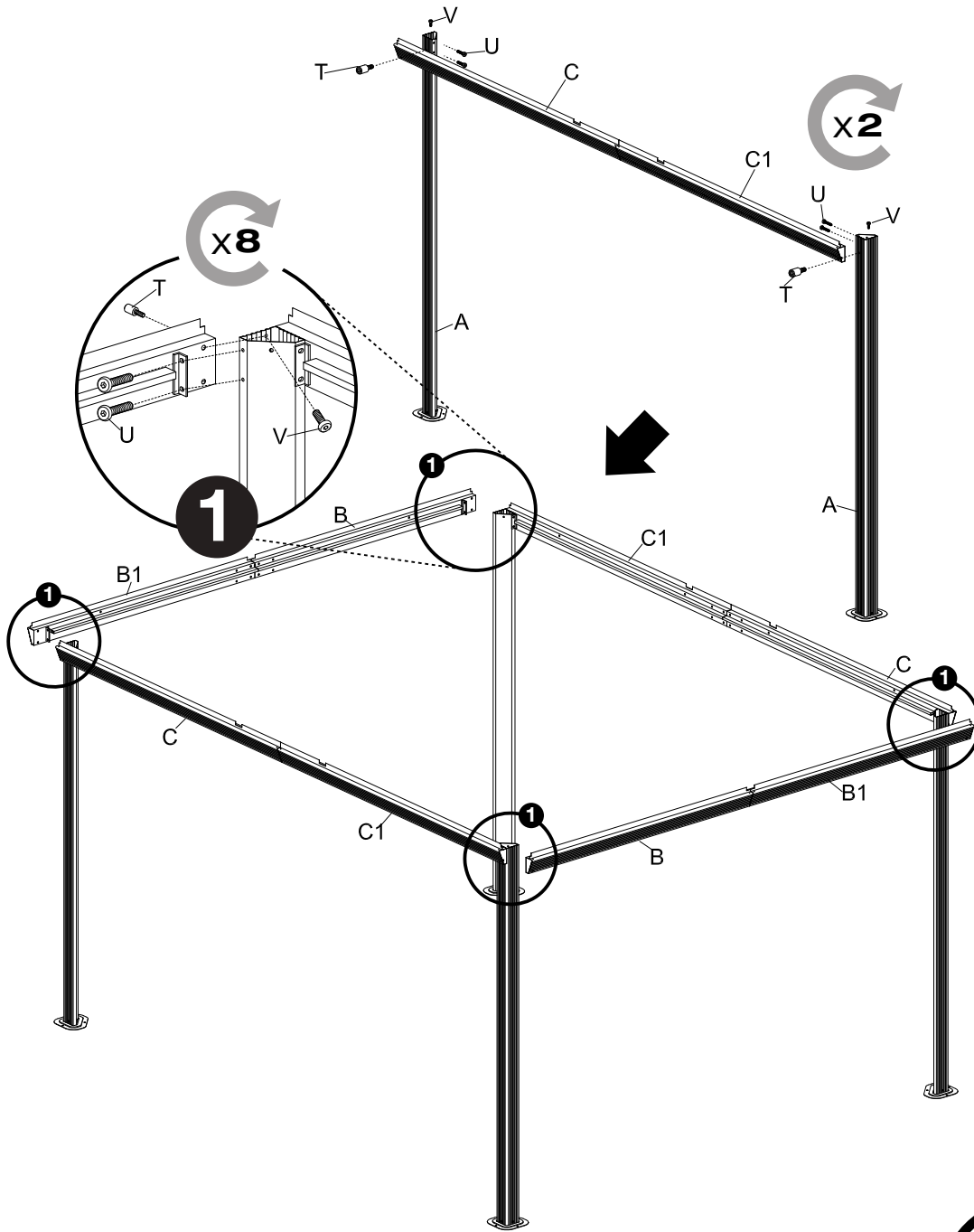

Tx8

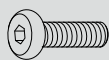

Ux16



Vx8

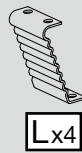
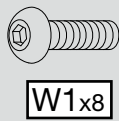
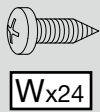
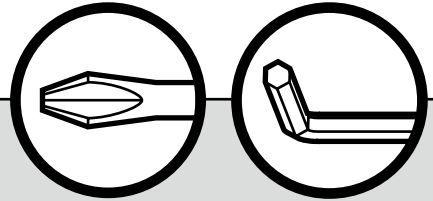
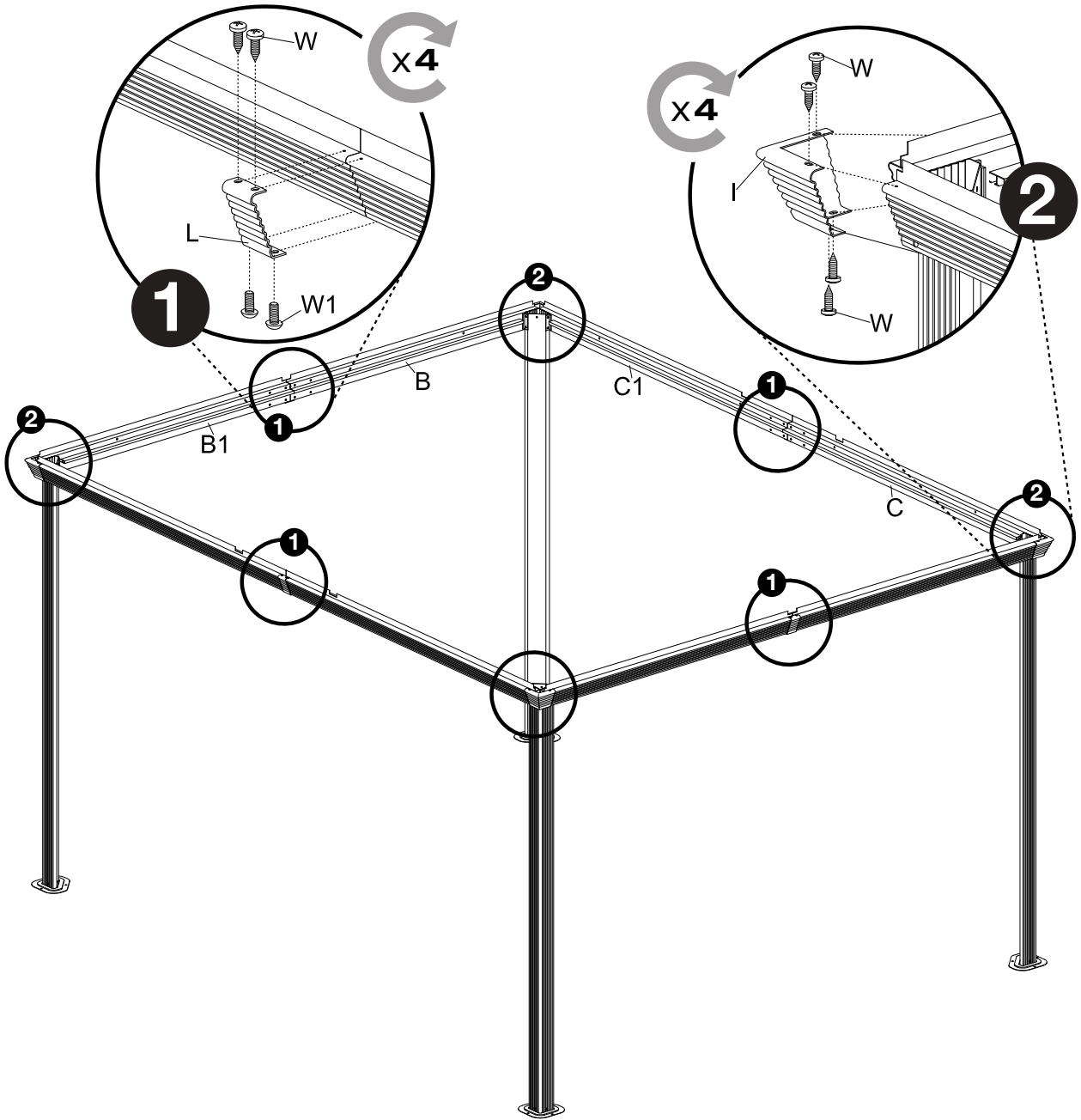

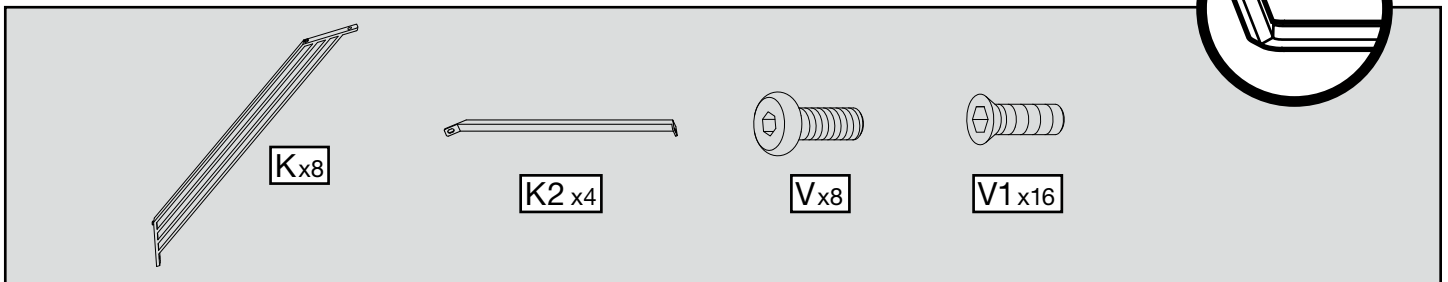
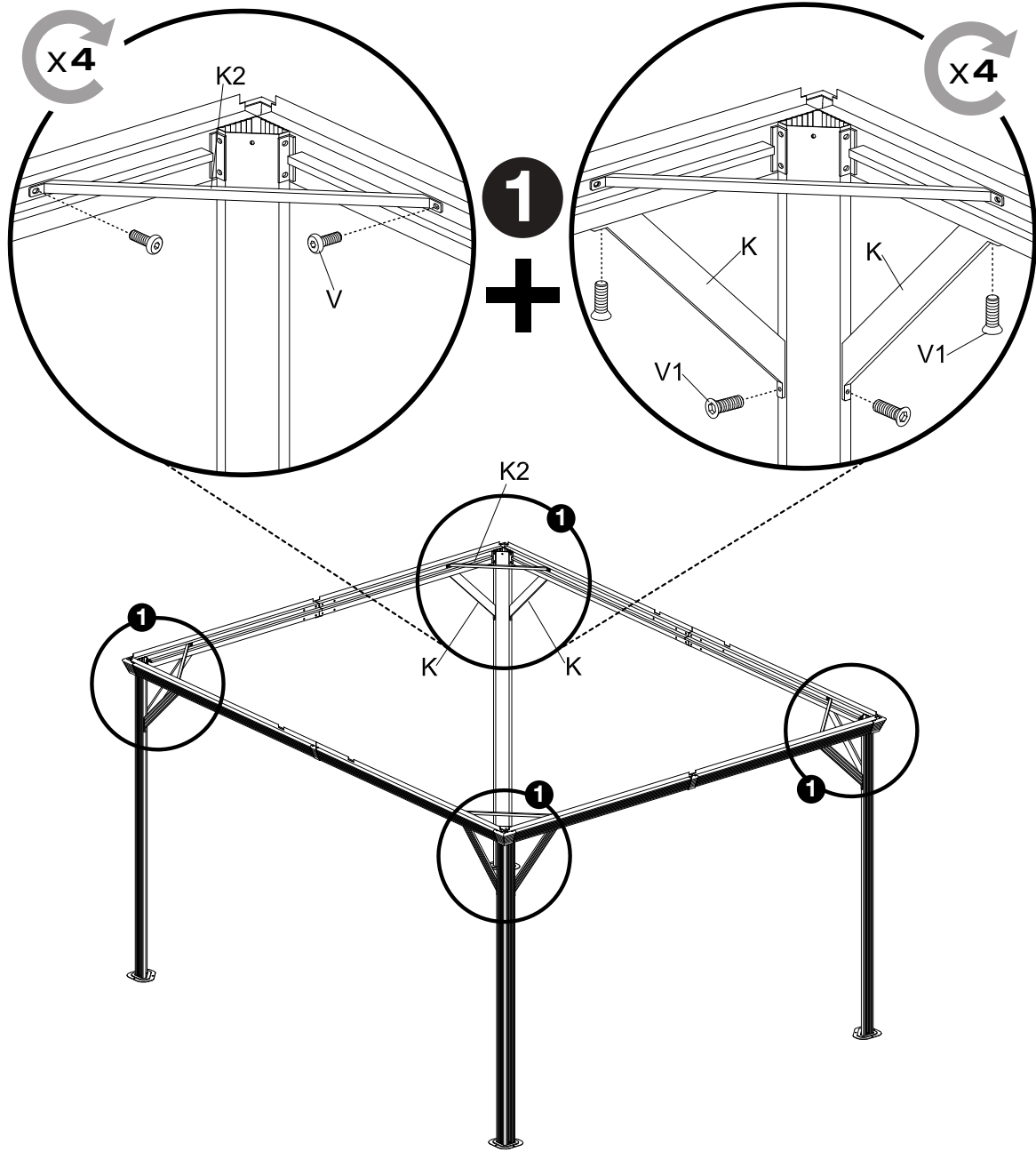

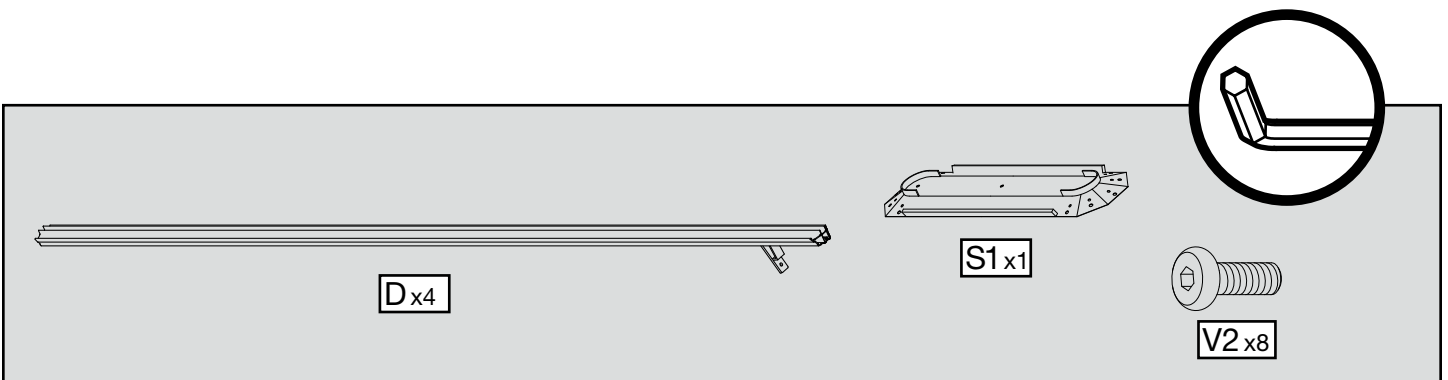
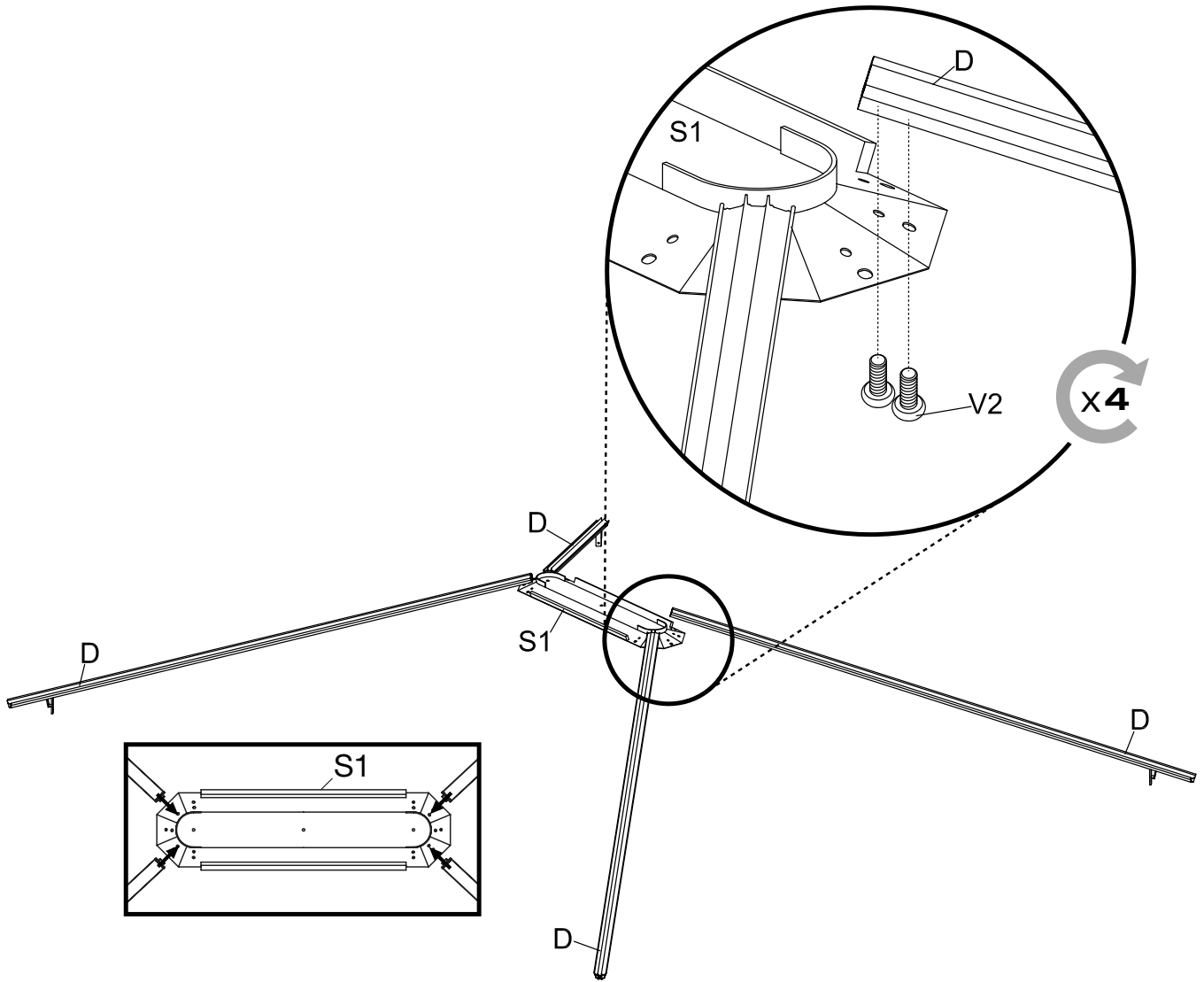

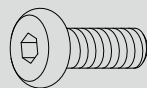
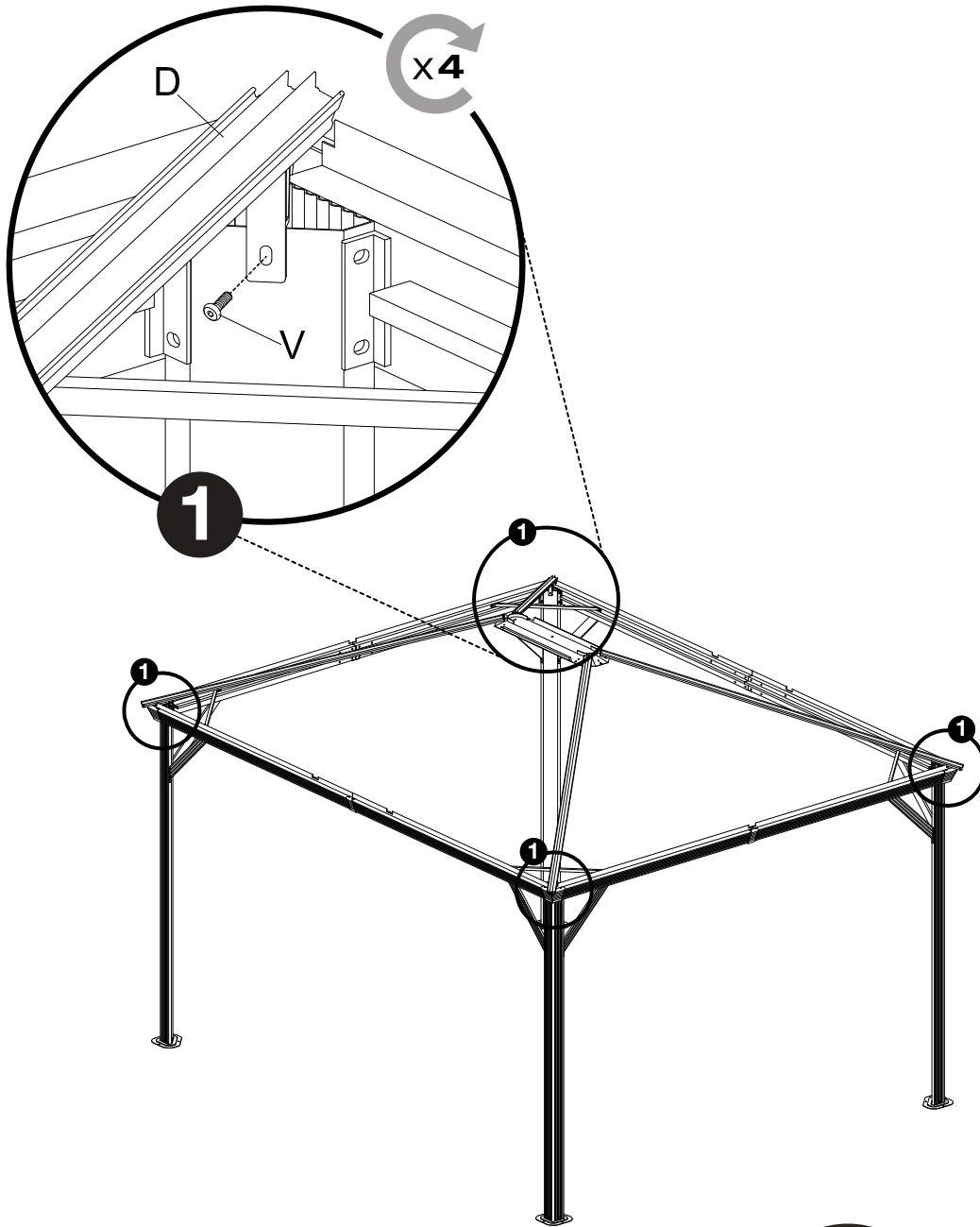

Vx4

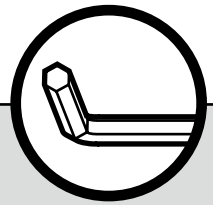

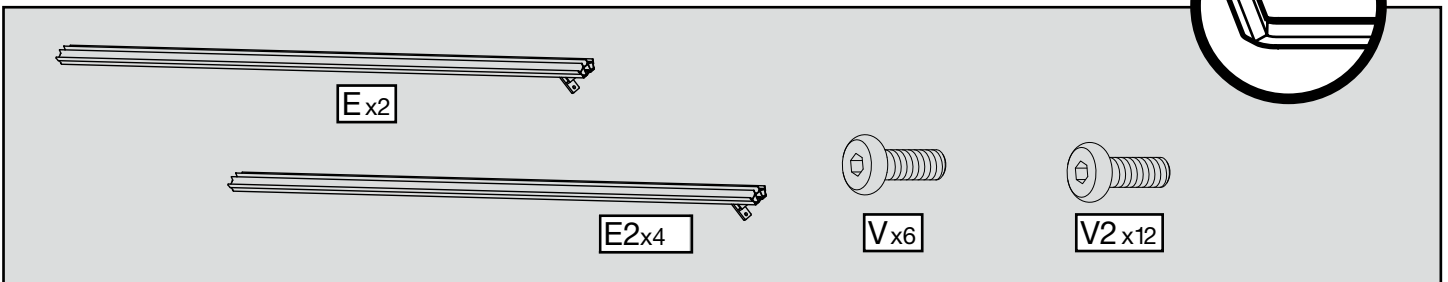
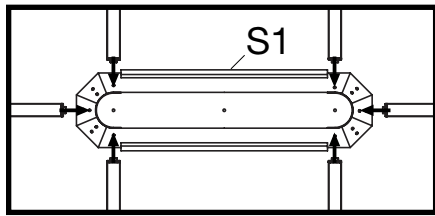
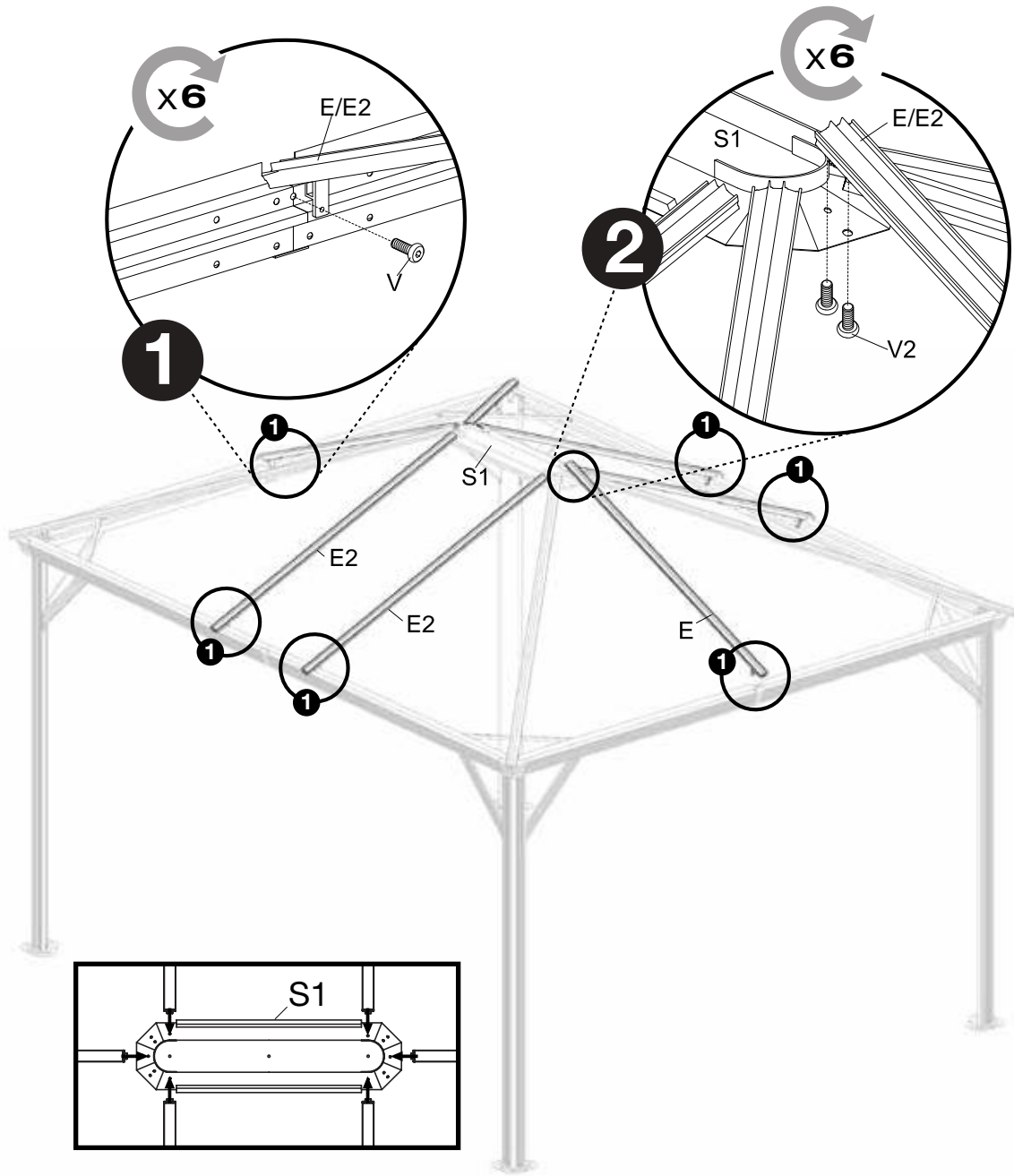

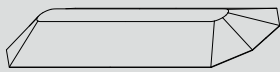
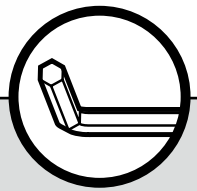
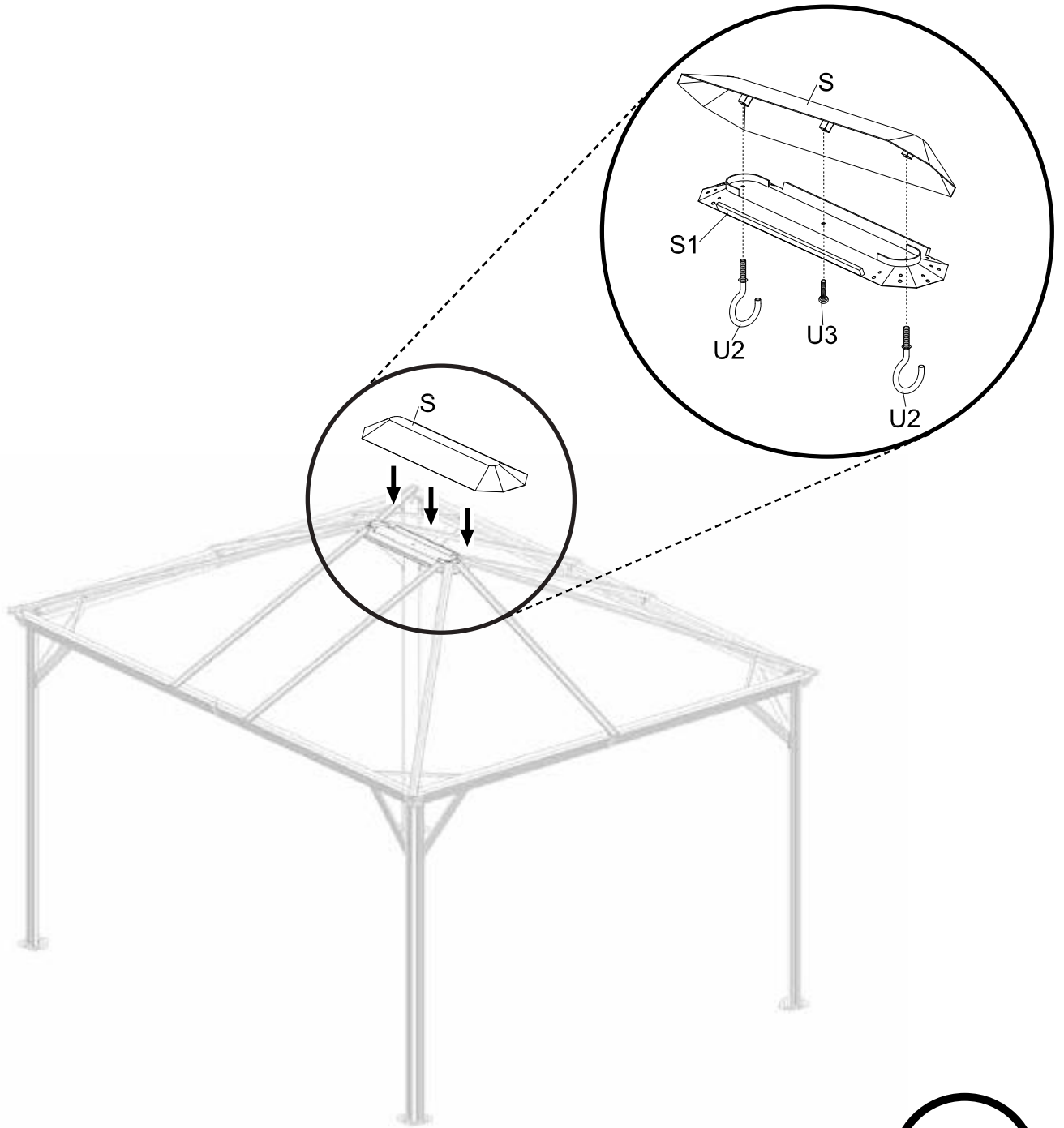

Sx1



U2x2

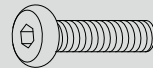

U3x1

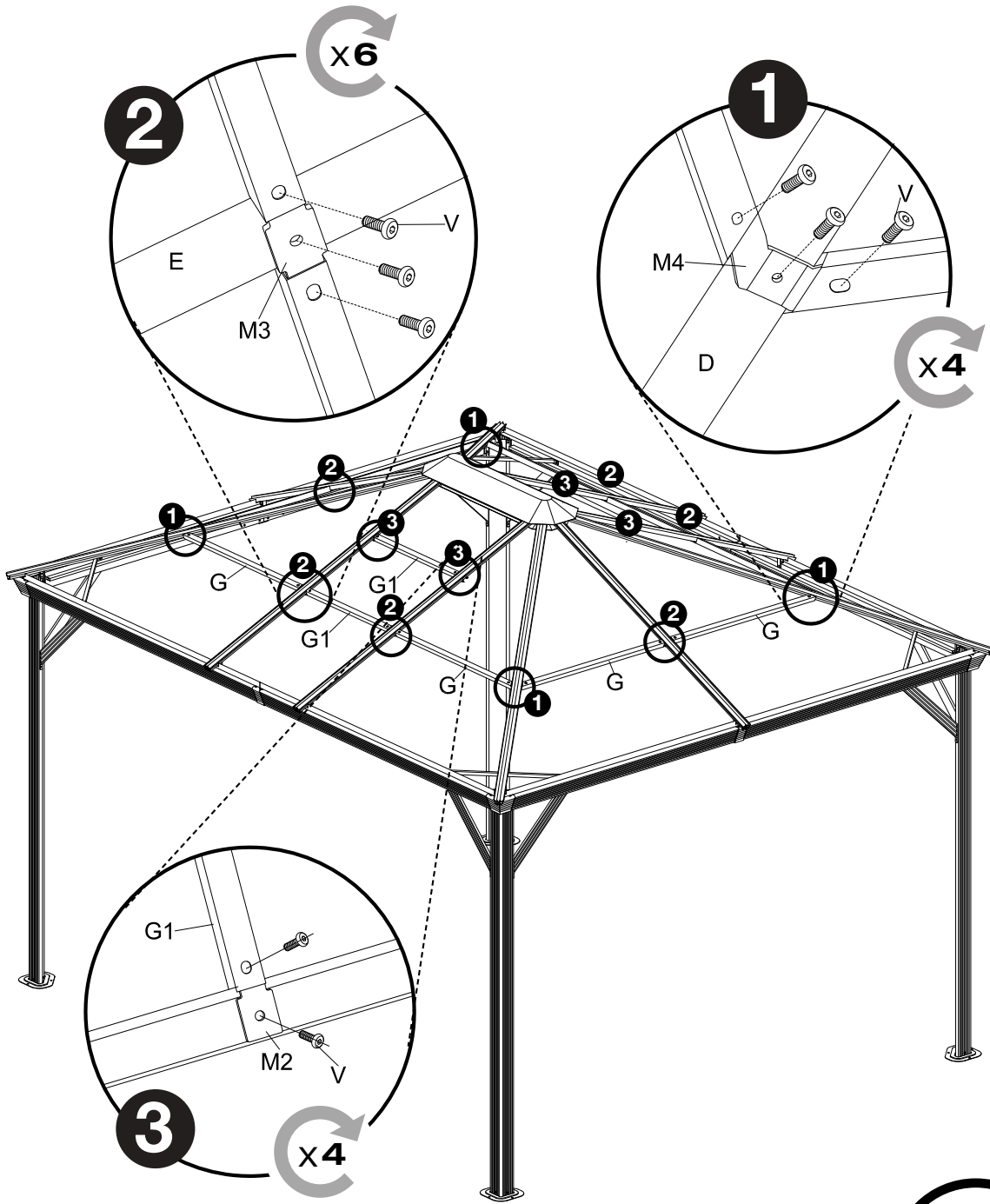

A parts list diagram showing the following components:

- Gx8
- G1x4
- M2x4
- M3x6
- M4x4
- Vx38
- Corner bracket

